

**spanet**



## Installation & user manual

CHP-33  
CHP-55



## Safety Messages

We have provided important safety messages in this manual about your heat pump.

Always read and follow all safety messages.



This is the safety alert symbol. It alerts you to hazards that can cause injury or harm to you and others.







This is a very important label. This symbol alerts you of things that **MUST** be strictly followed to ensure that your warranty will not be voided.



These are things that must be respected to protect the health of spa users and to ensure that your warranty will not be voided.

## Product safety symbols

	Warning; flammable materials
	Service indicator; read technical manual
	Read operator's manual
	Operator's manual; operating instructions

## Safety Warnings



**VITAL** Electrical power must be switched off before starting any work on heat pump.

**DO NOT** attempt to modify the internal configuration of the heat pump. Read entire installation manual before use.

This heat pump contains a flammable refrigerant R290. Any intervention/repairing of the refrigerant circuit is prohibited without a valid authorisation and performed by an accredited repairer. Please refer to detailed R290 safety warnings at the end of this manual.

- The installation, commissioning and maintenance of these heat pumps should be performed by qualified personnel having a good knowledge of standards and local regulations, as well as experience with this type of equipment.
- The appliance is intended to connect to fixed wiring. The means for disconnection must be incorporated in the fixed wiring in accordance with the wiring rules.
- The Eco Cube heat pump is preinstalled with a power cable for direct power connection to the SV spa control. If the installer decides to connect power to the heat pump from a source other than the SV spa control, all electrical connections must be performed by a licensed electrician and must confirm to all national, state, and local electrical codes in effect at the time of installation.
- It is the responsibility of the installer to ensure circuit breaker protection, considering the spa control and heat pump capacity. The SV spa control and Eco Cube heat pump should also be supplied through a residual current device (RCD) having a rated residual operating current not exceeding 30mA.
- The SV spa control must be connected to a suitable rated and weather protected power supply. The supply line should be a dedicated power circuit and means for disconnection must be incorporated in the fixed wiring in accordance with your local wiring regulations. Means for disconnection from the supply mains should have a contact separation in all poles that provide full disconnection under over voltage Category III conditions. If the Eco Cube heat pump does not source power directly from the SV spa control these precautions should also be followed for the heat pump power supply.
- The Eco Cube heat pump must be earthed to avoid any risks caused by insulation defects. The unit will be earthed via the preinstalled power cable which connects to the SV spa control. If a different power source is used, ensure the heat pump is connected to earth.
- Earthed appliances must be permanently connected to fixed wiring (European models).
- If the Eco Cube is to be installed within a general pool area or within 1.25m of a pool edge it is required to be equipotentially bonded. Refer to local electrical and safety standards in effect at time of installation.

- The data cable should be installed and run through UV resistant, corrugated conduit suitable for use in outdoor locations.
- The appliance contains no serviceable parts. Do not attempt service of this appliance. Contact your dealer or authorized service agent for assistance.
- Turn the mains power OFF before touching or modifying any cable connection.
- Low voltage or improper wiring may cause damage to this appliance. Read and follow all wiring instructions when connecting to power supply.
- If the supply cord is damaged, it must be replaced by the manufacturer, its service agent, or similarly qualified persons to avoid a hazard.
- It is the installer's responsibility to ensure the floor or mounting base can support the expected load of the heat pump and an adequate drainage system must be provided in case of overflowing or leaking water.
- This appliance must not be installed in proximity to highly flammable materials.
- Water temperature exceeding 38°C may cause hyperthermia (heat stress).
- This spa pool heat pump is for household use only.
- This appliance is not intended for use by persons (including children) with reduced physical, sensory, or mental capabilities, or lack of experience and knowledge, unless they have been given supervision or instruction concerning use of the appliance by a person responsible for their safety (IEC 60335-1)
- Children should be supervised to ensure that they do not play with the appliance.
- This appliance can be used by children aged from 8 years and above and persons with reduced physical, sensory, or mental capabilities or lack of experience and knowledge if they have been given supervision or instruction concerning use of the appliance in a safe way and understand the hazards involved. Children shall not play with the appliance. Cleaning and user maintenance shall not be made by children without supervision (EN 60335-1)
- Do not spray or paint insecticidal material on the surface of the heat pump.
- Do not block the evaporator by paper or any other foreign bodies to keep the unit well ventilated.
- You can clean the evaporator by washing with detergent and water at low pressure and then rinsing with clean water.
- Do not touch the air outlet grill when fan motor is running.
- The heat pump should be plumbed after the spa filters and NOT before, to prevent foreign objects or debris from entering heat pump.
- Spanet SV series heat pumps can only be used with Spanet SV series controllers.

## **! VITAL** ADDITIONAL WARNINGS

- Do not use means to accelerate the defrosting process or to clean, other than those recommended by the manufacturer.
- This appliance shall be stored in a room WITHOUT continuously operating ignition sources (for example: open flames, and operating gas appliance or an operating electric heater). Ideally the appliance should be installed OUTSIDE and away from such continuously operating ignition sources.
- Do not pierce or burn.
- Be aware that refrigerants may not contain an odour.



### Correct Disposal of this Product

This symbol indicates the product should not be mixed or disposed with general household wastes throughout the EU. Disposing of this product correctly will help save valuable resources and prevent any potential negative effects on human health and the environment, which could otherwise arise from inappropriate waste handling.

For proper treatment, recovery, and recycling, please take this product to designated collection points where it will be accepted free of charge. Alternatively, you may be able to return your products to your local retailer upon purchase of an equivalent new product. Please contact your local authority for further details of your nearest designated collection point. Penalties may be applicable for incorrect disposal.

## **! WARNING**

When ambient temperatures are close to or under freezing point, water circulation to the heat pump should never be stopped for more than 4 hours without completely draining the heat exchange. **In areas where freezing conditions are prevalent and sustained and when the heat pump is unlikely to be used, in advance of any freeze event, all water should be removed from the entire heat pump water circuit. Please refer to the "Winterising" section of this manual.**

**FREEZE DAMAGE IS NOT COVERED UNDER PRODUCT WARRANTY**



# Table of Contents

Safety Warnings .....	2
Table of Contents .....	5
1. Introduction .....	6
2. Specifications .....	7
3. Outlines & Dimensions .....	8
4. External Appearance .....	9
5. Internal Appearance .....	10
6. Installation Instructions .....	11
6.1 Recommended Air Flow Requirements .....	11
6.2 Installation Location.....	12
6.3 Pipework Insulation .....	13
6.4 Condensation Drain.....	13
6.5 Installation of Water Pipes.....	14
6.5.1 Connecting Water Pipes to Eco Cube .....	14
6.5.2 Connecting Water Pipes to Spa Pool.....	16
6.6 Plumbing Diagram.....	18
6.7 Filling Spa and Bleeding Air from Pipework .....	19
6.8 Cable Connections .....	20
6.8.1 Power Cable Connection .....	20
6.8.2 Data Cable Connection .....	22
7. Spa Controller Heat Pump Settings.....	23
7.1 Heat Pump Operation Mode (H.PMP) .....	23
7.1.1 Adjusting Heat Pump Operation Mode (H.PMP).....	23
7.2 Heat Pump with Electric Element Boost (H.ELE) .....	26
7.2.1 Adjusting Heat Pump + Electric Element Boost (H.ELE) .....	27
7.3 Set Temperature Adjustment and Range .....	30
8. Winterizing Heat Pump.....	31
8.1 Preparing for Freezing Conditions.....	31
8.1.1 Disable Heat Pump in SV Spa Controller Settings.....	31
8.1.2 Isolate Water Flow to Heat Pump (to continue using spa) .....	32
8.1.3 Drain Water from Heat Pump and Pipework .....	32
8.2 Prepare to Restart Heat Pump after Winter.....	33
8.2.1 Enable Heat Pump in SV Spa Controller Settings.....	33
9. Safety / Protection Systems .....	34
10. Maintenance .....	35
10.1 Evaporator Cleaning.....	35
10.2 Refrigerant Charging .....	35
11. Troubleshooting .....	36
12. Heat Pump Error Codes .....	38
13. Wiring Diagram.....	40
14. R290 Service Operations .....	41
Contact Us .....	47

# 1. Introduction

Thank you for choosing a SpaNET SV Series Eco Cube heat pump. Air sourced heat pumps are currently the most efficient and cost-effective method of heating and maintaining the heat of your spa pool water. The SpaNET SV Series heat pump technology heats your spa water using around 75% less energy than a conventional electric heater and 50% less energy than natural gas resulting in an eco-friendly and highly cost-efficient appliance. It also allows for maximum heating input and reduced heating times on low amperage power supplies. The SV Series heat pumps have been engineered for maximum heating efficiency however as a by-product of refrigeration technology, they can offer cooling of the spa water as well.

SpaNET SV Series heat pumps have been specifically designed to integrate to SpaNET SV Series spa controllers. SpaNET heat pumps will NOT operate on any other spa control system. They do not have a separate keypad for adjusting settings; rather they feature a dedicated interface to the SV Series spa controller allowing all temperature settings and mode adjustments to be conveniently controlled via the spa side keypad.

They offer a truly integrated heat pump solution for a spa pool that can not only provide automatic heating of the spa water, but automatic cooling of the spa water as well. Simply set your desired water temperature on the spa side keypad and the SV heat pump will automatically heat or cool the water (when required) to maintain your desired water temperature level (from 5°C to 41°C).

They offer outstanding efficiency, low noise and high build quality. They are easy to use and maintain and when installed correctly will provide years of trouble-free service. Please read this instruction manual carefully before use and follow all installation guidelines to prevent damage to the device and ensure long term reliability.

## IMPORTANT

1. In extreme cold weather (sustained temperatures below 0°C), if the heat pump is no longer needed, it is important to isolate water flow to the heat pump and drain all water from the inside of the heat pump. Please refer to the "Winterising" section of this manual.
2. The heat pump should NOT be installed in an airtight location or confined space, such as a basement, garage or under a deck. The heat pump requires good air ventilation. It will discharge cold air when heating and hot air when cooling, and efficiency depends on the ability to draw normal ambient temperature air and discharge the cold or hot air well away from the unit. It is recommended to install the heat pump away from any other home appliances, to avoid the chance of electromagnetic interference. Please refer to the "Air Space Requirements" section of this manual.
3. In very hot weather (ambient temperatures  $\geq 36^{\circ}\text{C}$ ) and where the spa water temperature  $\geq 34^{\circ}\text{C}$  and the heat pump is set to AUTO or COOL mode and operates to cool the water, it is possible that the critical temperature of the R290 refrigerant is exceeded once the heat pump has been operating for a period of time and a high pressure error condition may occur to protect the compressor. If this occurs wait until the ambient temperature falls before attempting to cool again or cool the spa water in advance of any forecast hot weather event. Heat pumps installed in highly sun exposed areas or locations with restricted air ventilation will be more susceptible to this situation.

## 2. Specifications

	CHP-33	CHP-55
<b>ELECTRICAL</b>		
Power supply	220-240V ~	220-240V ~
Phase / Hertz	1PH / 50 Hz	
Electrical Connection	AMP Plug	
Rated Current (A)	3.5	5.5
<b>ENVIRONMENTAL</b>		
Operating Air Temperature	-2°C to 43°C	
Waterproof Class	IPX5	
<b>PERFORMANCE CONDITION: AIR 27°C / WATER 26°C IN 28°C OUT / HUMIDITY 80%</b>		
Heating Capacity (kW)	3.4	5.5
Power Input (kW)	0.62	0.95
COP	5.5	5.7
<b>PERFORMANCE CONDITION: AIR 15°C / WATER 26°C IN 28°C OUT / HUMIDITY 70%</b>		
Heating Capacity (kW)	2.3	3.6
Power Input (kW)	0.56	0.85
COP	4.1	4.2
<b>PERFORMANCE CONDITION: AIR 35°C / WATER 29°C IN 27°C OUT / HUMIDITY 70%</b>		
Cooling Capacity (kW)	2.1	3.5
Power Input (kW)	0.7	1.1
EER	3	3.1
<b>MECHANICAL</b>		
Compressor	Rotary	
Heat Exchanger	Twisted Titanium	
Refrigerant	R290, 200g	R290, 260g
CO <sup>2</sup> Equivalent	600g	780g
Water Connection (mm)	32/38	32/38
Minimum Flow Rate (LPM)	65 (4m <sup>3</sup> /h)	80 (5m <sup>3</sup> /h)
Nose @ 1M (dBA)	47	50
Noise @ 10M (dBA)	37	40
Net/Gross Weight (kg)	29/31	32/34
Net Unit Size L/W/H (mm)	560 x 445 x 495	
Carton Size L/W/H (mm)	648 x 510 x 568	

- Specifications are subject to change without notice for further improvement.



### 3. Outlines & Dimensions

Dimensions Drawing (mm)

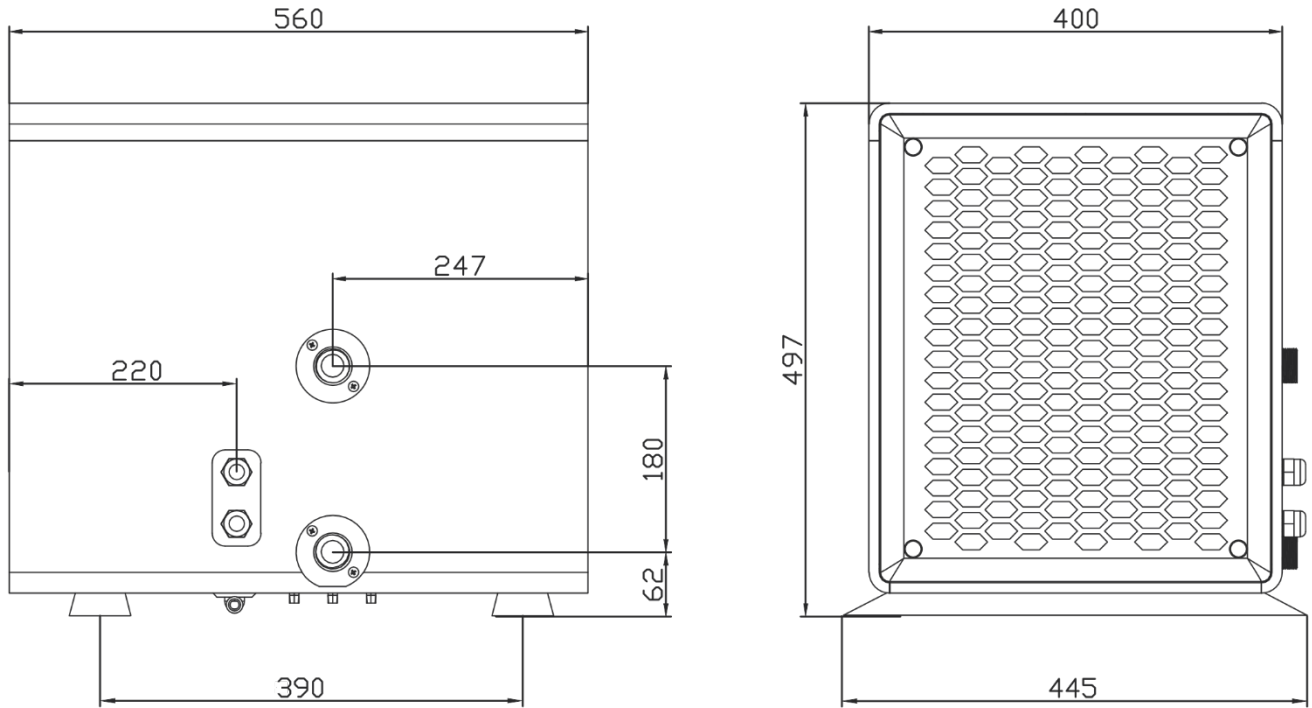

## 4. External Appearance

1	Air inlets
2	Air outlet (fan exhaust)
3	Water inlet
4	Water outlet
5	Power cable entry
6	Data cable entry
7	Condensation drain

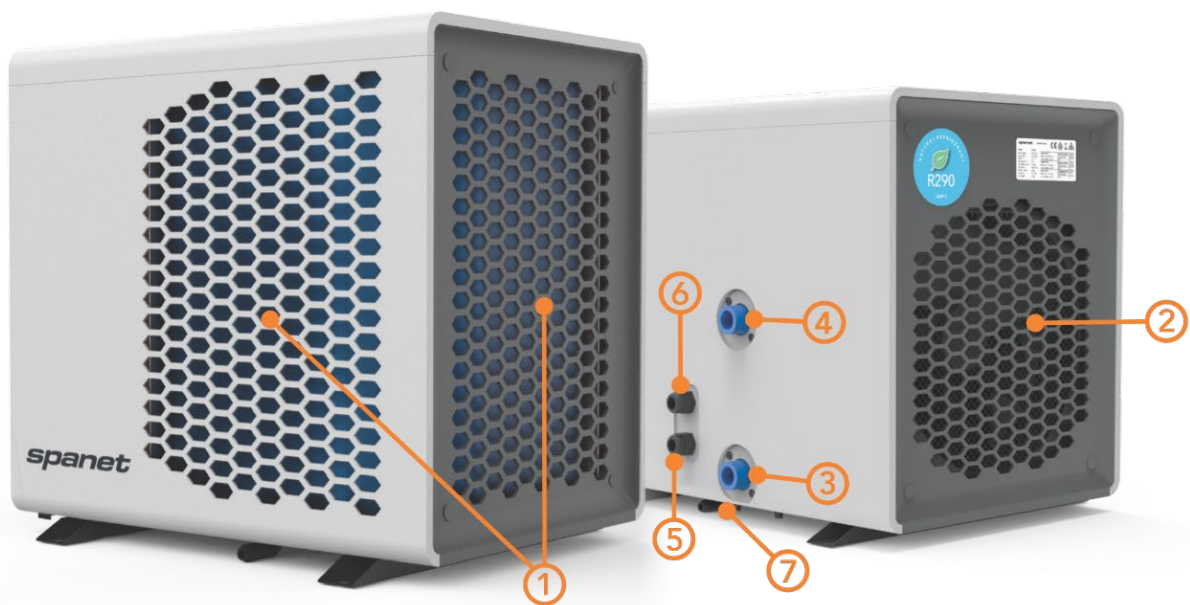

## 5. Internal Appearance



7	Condensation drain
8	Evaporator
9	Fan
10	Compressor
11	4-way-valve
12	Titanium in PVC heat exchanger
13	Water flow switch
14	Heat exchange thermal cut out
15	Equipotential bonding point

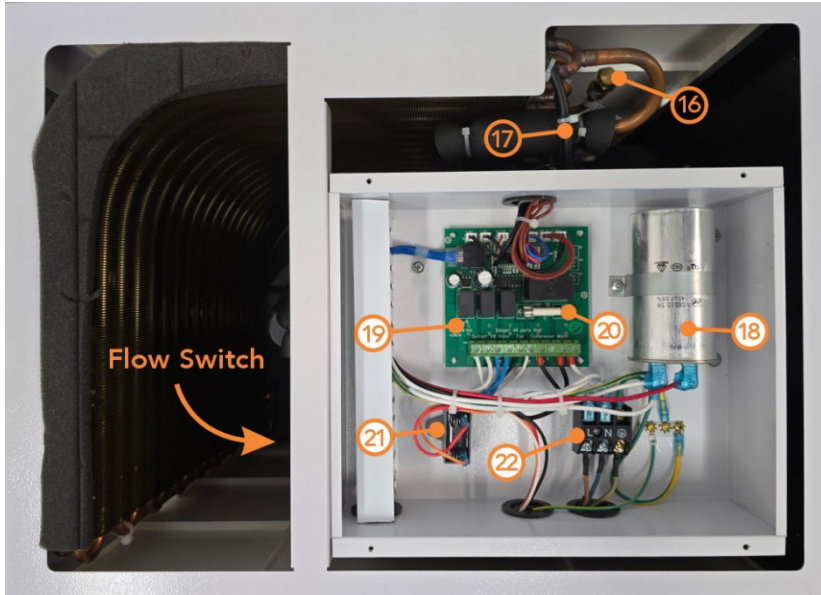

16	Refrigerant fill point
17	Ambient thermistor
18	Compressor capacitor
19	Circuit board
20	20A slow blow mains fuse
21	Fan capacitor
22	Mains terminal block

## 6. Installation Instructions

### 6.1 Recommended Air Flow Requirements

The performance and efficiency of a heat pump is directly correlated to its ability to freely draw outside ambient air through its intakes and discharge air via the exhaust fan outlet without obstruction. Obeying the below recommended air space requirements and preventing any restriction to air flow is critical to achieve optimal performance and COP output from your Eco Cube.

In addition, when a heat pump is heating the exhaust fan discharges cold air, when it is cooling it discharges warm air. Avoid installing in an area with confined air space (i.e. under a deck or in a room) even if that confined space has ventilation. When the heat pump is operating, in a short space of time it will significantly decrease/increase the temperature of that confined air volume which in turn will reduce the efficiency and heating/cooling performance output of the heat pump. Altered environmental conditions due to confined space also put additional stress on the major components, making them work harder which could reduce expected life span and reliability of the product.

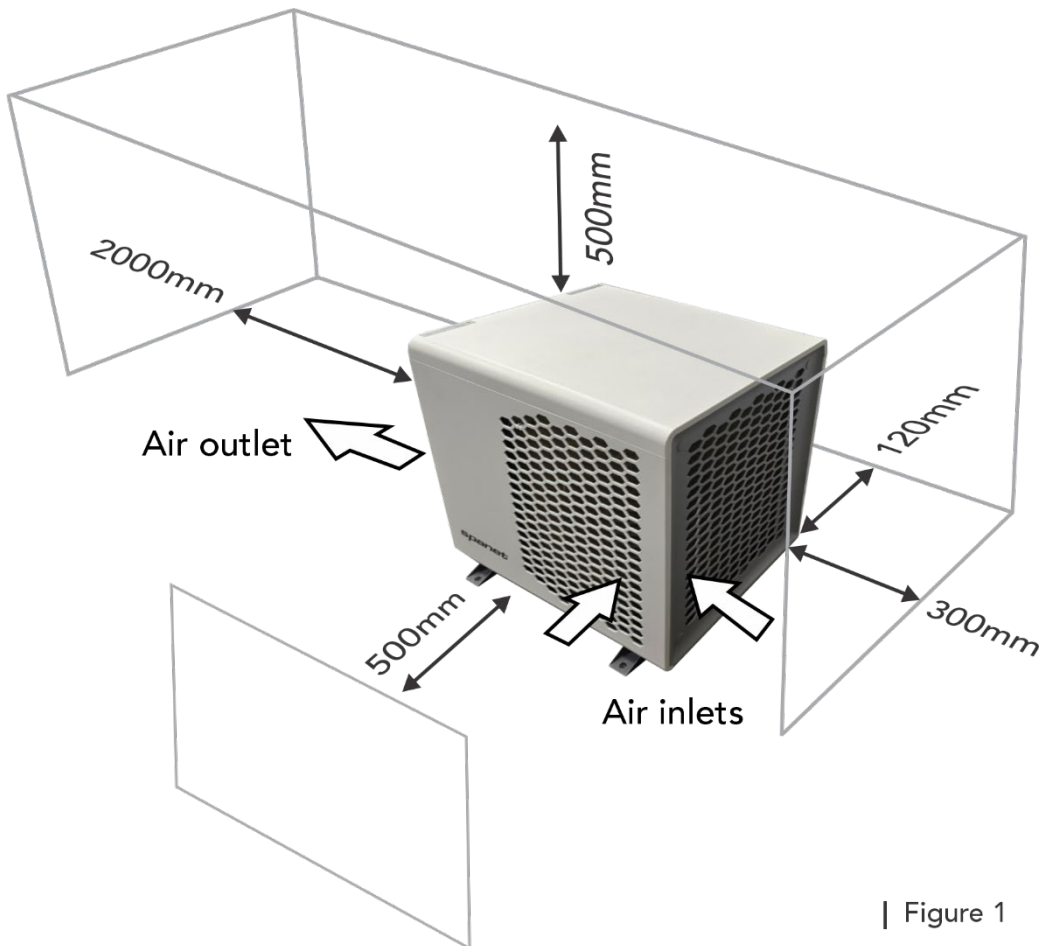

| Figure 1

#### **⚠ WARNING**

The heat pump **MUST** be installed according to the air space requirements shown in Figure 1. Failure to follow these instructions may **VOID WARRANTY**.

## 6.2 Installation Location

Select a suitable location in accordance with below notes and consult the local council and swimming pool safety regulations to check requirements for proximity to other equipment.

- The heat pump must be located outside in a clean area where air flow will not be restricted.
- **Install close to the spa pool to minimise pipe work exposed to environmental conditions. The Eco Cube has been designed to be installed directly beside one side of the spa.**
- The heat pump must operate with a clean air supply so should be situated away from vegetation and obstacles.



### IMPORTANT

1. The heat pump must be installed on a flat, solid and large enough base to properly secure the heat pump. Whilst it can be mounted on wall brackets or stands, a level concrete base is preferred.
2. If installing the heat pump in a harsh climatic area (i.e. sub-zero temperatures, snow, humidity), it is recommended to raise the unit 300mm above the ground and protect the heat pump from possible snow fall.
3. During installation, ensure sufficient free space is left around the heat pump for future maintenance.
4. The unit is air cooled. It must be installed outdoor in an area with sufficient clearance to provide enough air circulation through evaporator.
5. **DO NOT** install heat pump in a confined space to prevent recycling of air which decreases performance and adds stress to mechanical components.
6. The fan should not blow towards windows, walls, or spaces likely to be inhabited by people or animals.
7. Do not install where the heat pump is likely to be subjected to polluted air, dust, or debris.
8. Avoid directing fan output against the dominant wind directions.
9. Minimise exposure to environmental conditions as much as possible and never restrict or block the airflow.
10. Ensure the heat pump is installed in an area that is free from flammable and corrosive chemicals, and grease.

### ⚠ VITAL

Unless you are certain the heat pump has remained in its normal, upright orientation during transit and throughout installation (i.e. has not been laid on its side or end at any time), **the heat pump should remain powered OFF and NOT used for 24 hours after its installation to prevent damage to the compressor.**



## 6.3 Pipework Insulation

To prevent heat loss, reduce power consumption and to protect the pipes from UV exposure, it is recommended that all external pipework should be insulated with pipe lagging (example below).



## 6.4 Condensation Drain

During humid conditions, as part of the heat exchange process, the evaporator may produce a large amount of condensation runoff. A condensation drain elbow is supplied with the heat pump so that condensation run off can be directed to a suitable location. The Eco Cube base has a hole located directly beneath the power/data cable glands for fitment of the condensation drain elbow. Please install the drain connector by press fitting the connector into the hole, as shown in the picture below (prior to installation of the water pipes). Then connect a 12mm hose to the elbow to direct the runoff to a suitable location.

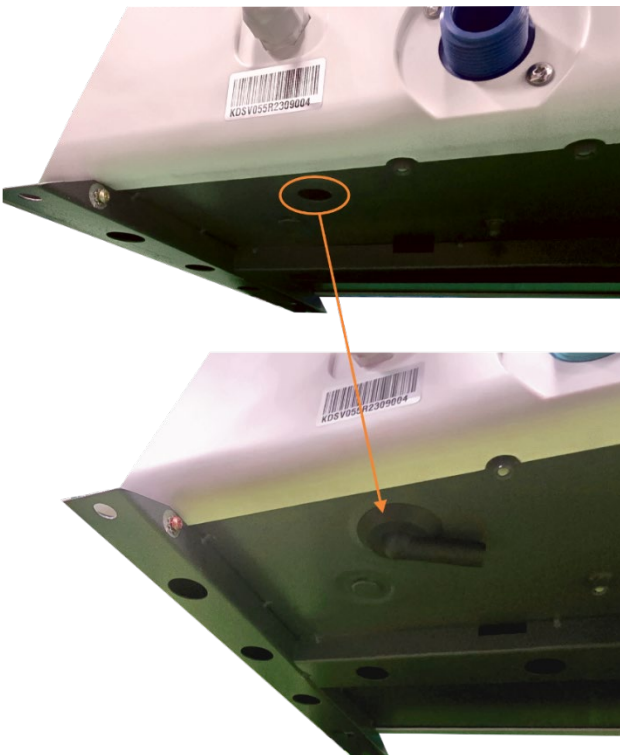

### **⚠ WARNING**

In very cold climates (i.e. sustained temperatures below 0°C) the drain connector should not be used to prevent becoming blocked with ice during periods of idle activity.

## 6.5 Installation of Water Pipes

The Eco Cube has two threaded 25mm (G1) BSP-P water connection ports on the rear of the unit. For convenience 2 x 32mm/38mm hose connector fittings (SKU: CHP-OT3832) and 2 x 21-38mm stainless steel hose clamps (SKU: CHP-HC2138) are provided for fast, simple connection of flexible water pipes without the need to use pipe glue\*.

When connecting the Eco Cube to a new spa pool, your spa manufacturer should have already provisioned 2 x 32mm or 38mm water ports underneath the spa cabinet. Where the Eco Cube is being retrofitted to an existing spa pool or being installed on a spa which is not plumbed 'heat pump ready' you can utilise our 40mm/32mm reducing bushes (SKU: CHP-RB4032) to convert 40mm pressure pipe down to 32mm flexible pipe. These can be purchased from Spanet separately.



SKU | CHP-OT3832



SKU | CHP-HC2138



SKU | CHP-RB4032



### IMPORTANT

\* **NOTE** - Whilst it is acceptable to fit the water pipes without glue using only the hose clamps, some installers may prefer to use PVC pipe cement as well as the hose clamps for a superior long-term connection. **However, if the Eco Cube is to be installed in an area that experiences sustained sub-zero temperatures during Winter, we do NOT recommend using PVC cement as it will make the Winterization process difficult to drain water from the Eco Cube as required.**

### 6.5.1 Connecting Water Pipes to Eco Cube

Water flow through the heat pump is directional. If the Eco Cube is plumbed incorrectly the heat pump will not operate due to a "Heat Pump Flow Error". Before you begin, ensure you have studied the plumbing diagram within this manual to familiarize yourself with the required water flow direction. Water should flow out from the spa to the bottom inlet port of the heat pump, then return to the spa from the top outlet port of the heat pump.

**Step 1:** Check each 32/38mm hose connector has the O-ring seated at the base of the thread.

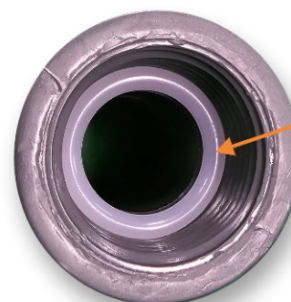

Check for  
O-ring

**Step 2:** Tightly screw hose connectors onto the heat pump inlet and outlet ports as pictured below.

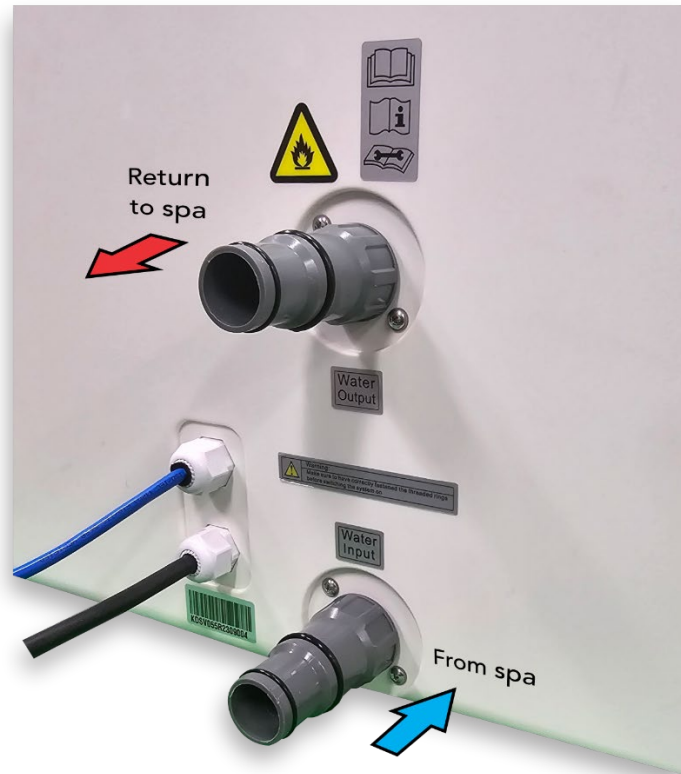

**Step 3:** Use a heat gun to lightly heat the flexible pipe to make the plastic supple then push onto the hose connector taking care to push the pipe well past the O-ring\*. Then seat the hose clamp at the end of the hose (ensure the clamp is positioned after the connector O-ring) and tighten securely.

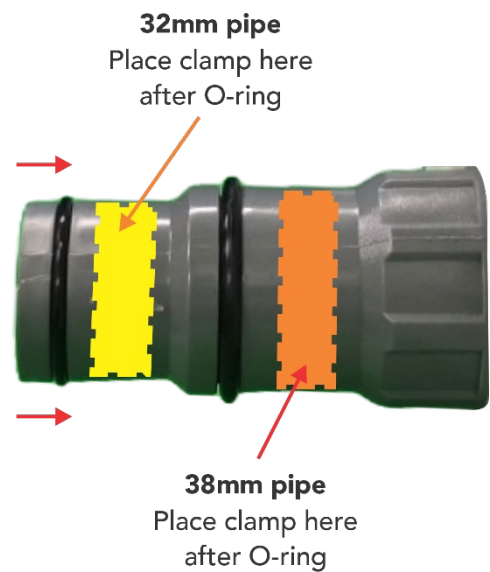

*\*If you wish to use PVC pipe cement add glue after heating but before pushing pipe onto connector.*

**Step 4:** Repeat the process in step 3 for the second pipe.



### 6.5.2 Connecting Water Pipes to Spa Pool

Remove the spa cabinet to access the equipment bay and locate the 'heat pump ready' connection ports provided by your spa manufacturer (example shown in picture below). Study the plumbing to identify flow direction and connect pipes accordingly. Upon completion of pipe connection, the valve positions will need to be checked/adjusted as per comments in the Plumbing Diagram in this manual.

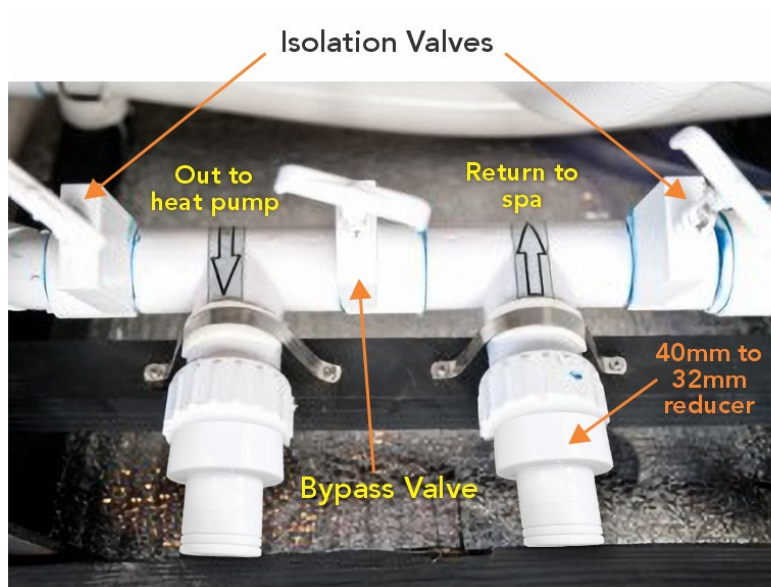

#### **⚠ WARNING**

Connection points will vary among different spa manufacturers. Some may even direct plumb to the heat pump without using a bypass valve. A bypass valve is not required unless a 2-speed filter pump is fitted where it MUST be used to limit water flow through heat pump in high speed.

**Step 1:** Use a heat gun to lightly heat the flexible pipe to make the plastic supple then push onto the reducing bush taking care to push the pipe well past the moulded O-ring ridge\*. Then seat the hose clamp at the end of the hose (ensure clamp is positioned after O-ring ridge) and tighten securely.

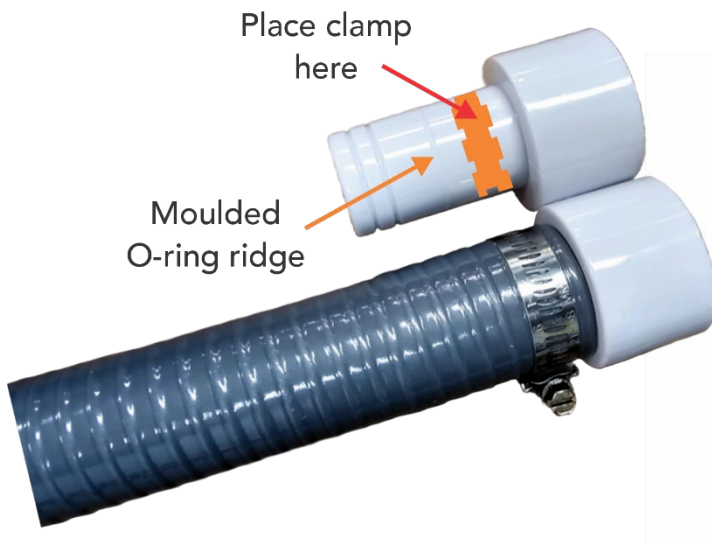

*\*If you wish to use PVC pipe cement add glue after heating but before pushing pipe onto connector.*

**Step 2:** Repeat the process in step 1 for the second pipe.



**Step 3:** Adjust the position of the bypass and isolation valves (if fitted) as per the comments in the plumbing diagram contained in this manual.

**⚠ WARNING**

Once the pipe work is full of water it will become heavy and will place strain on the heat pump outlets if the pipe work is not supported. **DO NOT have long runs of pipe in mid-air above the ground without support.** If the pipe work is unsupported the strain could cause stress damage to the outlets and potential leaks. **IT IS THE INSTALLER'S RESPONSIBILITY TO ENSURE THE PIPE WORK IS ADEQUATELY SUPPORTED TO PREVENT MOVEMENT AND STRESS.**



## 6.6 Plumbing Diagram

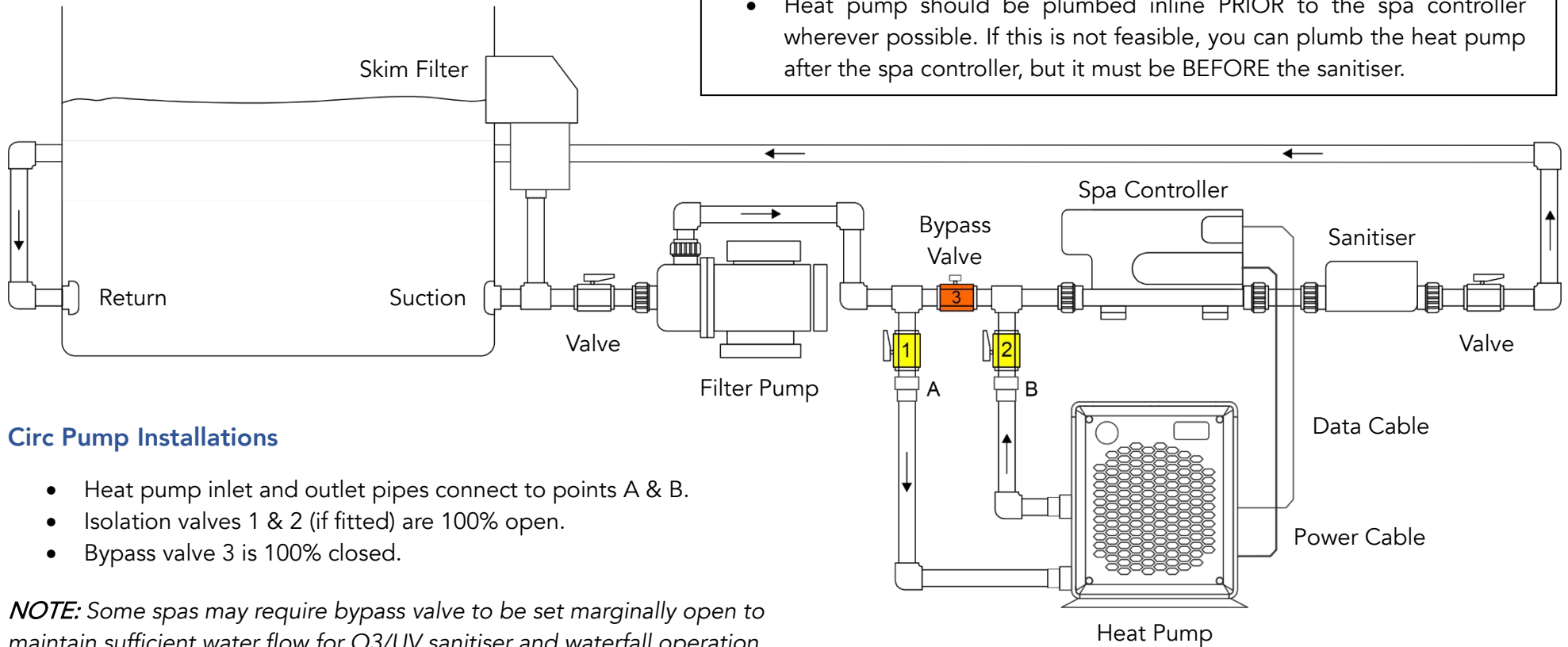

### ⚠ WARNING

- Heat pump should be plumbed on the DISCHARGE side of filter pump.
- Heat pump should be plumbed inline PRIOR to the spa controller wherever possible. If this is not feasible, you can plumb the heat pump after the spa controller, but it must be BEFORE the sanitiser.

### Circ Pump Installations

- Heat pump inlet and outlet pipes connect to points A & B.
- Isolation valves 1 & 2 (if fitted) are 100% open.
- Bypass valve 3 is 100% closed.

**NOTE:** Some spas may require bypass valve to be set marginally open to maintain sufficient water flow for O3/UV sanitiser and waterfall operation.

### 2-speed Pump Installations

- Heat pump inlet and outlet pipes connect to points A & B.
- Isolation valves 1 & 2 (if fitted) are 100% open.
- Bypass valve 3 is 50% closed / 50% open.

**NOTE:** With small HP 2-spd pumps the bypass valve may need to be further closed to maintain sufficient water flow through heat pump in low speed.

## 6.7 Filling Spa and Bleeding Air from Pipework

Spa pools are susceptible to air locks in pipework when filling with water due to the complex nature of their plumbing. The inclusion of a heat pump to the plumbing circuit adds to this complexity, increasing the risk of air locks. Air locks in pipework cause water flow errors within the heat pump and/or spa controller which prevents the equipment from operating. Follow the steps below to minimise chance of air locks occurring when filling the spa.

1. Once the plumbing to the heat pump has been completed and been given sufficient time for the PVC cement/glue to cure (if used), the spa should be filled with water. Keeping the mains power to the spa turned OFF, set the position of the bypass and isolation valves as instructed on the plumbing diagram based on type of filtration pump fitted to the spa.
2. Completely remove ALL filter cartridges from the skim filter and place them beside the spa.
3. Place a garden hose inside the skim filter and turn on full pressure to start filling the spa via the filter box. DO NOT place hose in bottom of spa. The spa MUST be filled through the filter box to flood the pipework before filling the body of the spa and reduce chance of air locks.
  - a. If there are multiple ports inside the filter box, keep switching the hose between each port every 10 minutes until the spa is filled.
4. Once the spa has reached the water fill line (approximately halfway up the skim filter mouth), locate the spa controller heater and identify which heater coupling is on the return side of the plumbing. Slightly loosen the coupling on the return side to take pressure off the O-ring and allow any residual air in the pipe work to escape (this process is called bleeding). Once the air has escaped and there is a constant stream of water, re-tighten the coupling sufficiently.
5. With the heat pump power and data cable remaining DISCONNECTED from the SV controller, supply power to the spa and operate the filtration pump to complete purging any air from the heat pump and pipe work. Allow filtration pump to run and ensure you can see and feel the water returning to the spa.
  - a. **NOTE:** If you cannot see the water returning to the spa, turn the power OFF immediately and attempt to bleed more air from the pipe work by loosening the return coupling on the spa control heater again, and/or at the filtration pump discharge coupling if required. Be sure to re-tighten all couplings sufficiently after bleeding.
  - b. Once the air has been bled and water is freely flowing and returning to the spa, operate the filtration pump for several minutes and check for any drips and leaks from the pipework. Take corrective action to resolve any drips/leaks if present.
6. Now that the pipe work has been bled of air and has been checked for leaks it is time to turn the spa power back OFF and connect the heat pump power and data cables to the SV controller (refer to the "Cable Connections" section of this manual).

## 6.8 Cable Connections

Data and power cables must be installed between the heat pump and spa pool in accordance with the local wiring regulations. It is best practice to separate data and power cables from each other.

### 6.8.1 Power Cable Connection

The Eco Cube requires connection to a constant 230V power supply. It is supplied with a preinstalled 5m AMP power cable ready for direct connection to a 230V OUTLET socket provided on the SV Series spa controllers (shown below), without the need for an additional power circuit.



#### **⚠ WARNING**

On SV3 and SV4 models it is **recommended to always use the first 230V outlet** (located between the Pump2 and Pump3 sockets). The second 230V socket (on the right-hand side) should only be used in 3-phase connections, where preference is for the heat pump to connect to Phase 3.

### 6.8.1.1 AMP Sockets & Plugs

SV series spa controllers utilise AMP mate-N-lok power connectors. The AMP connectors feature a key pattern for fail-safe one-way connection. When connecting the power cable push the plug firmly into the socket and ensure both side locking tabs have been secured and latched in place.

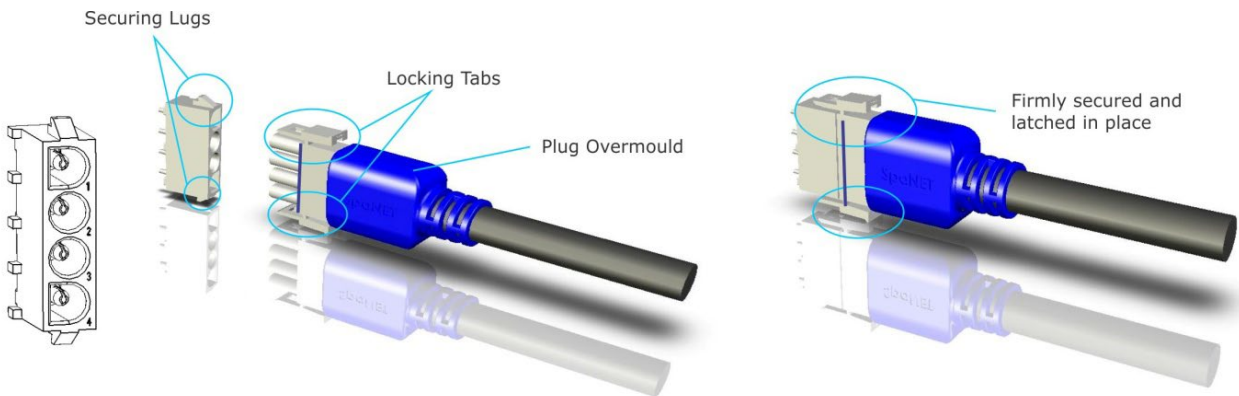

### 6.8.1.2 Equipotential Bonding Point

Equipotential bonding is the practise of intentionally connecting all metallic items in a zone together to protect from electrical shocks. Most national Swimming Pool and Spa Pool Safety Standards and local Wiring Rules require that any electrical equipment located within a 'wet zone' (within an arm's length (1.25m) of the water) shall have an equipotential bond to an earth bonding connection point associated with the power circuit supplying the pool or spa.

Depending on the installation location of the Eco Cube, the type and size of the spa it is being connected to and proximity to a swimming pool an equipotential bond wire may or may not be required. The Eco Cube has an equipotential bond point on the back foot on the rear of the heat pump (pictured below) should a bond wire be required. All SV Series spa controllers feature an earth bonding bar for connecting the bond wire to.



## 6.8.2 Data Cable Connection

The Eco Cube heat pump is a slave device and is operated by an SV spa controller. It requires a data cable connection for communication between the spa controller and the heat pump itself. It is supplied with a preinstalled 5m shielded data cable ready for direct connection to an SV Series spa controller.

The data cable connects to a dedicated Heat Pump data socket labelled **EXP2** in the low voltage connection area of the spa control. The Eco Cube will only work if connected to the EXP2 socket.

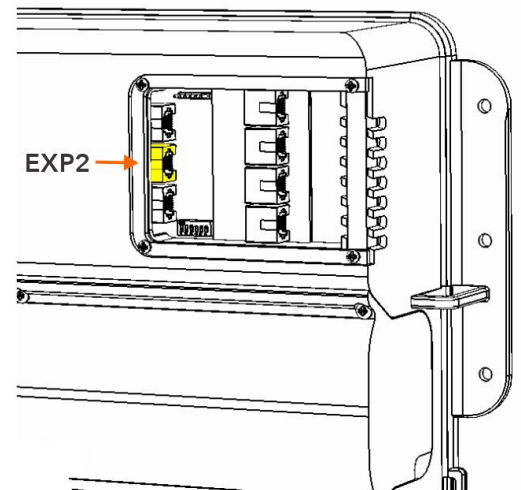
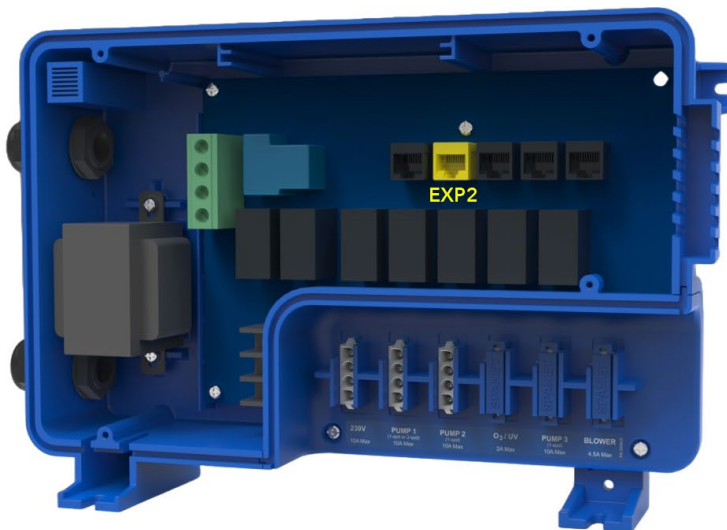

### **⚠ WARNING**

1. The data cable must be installed into a UV resistant, corrugated conduit suitable for use in outdoor locations between the heat pump and spa cabinet.
2. There should be adequate separation between the communications (data) cable and power cable to prevent data corruption. The data and power cables should not be tied side by side or placed in shared conduit. Separate cables by 150-300mm.
3. **Do NOT cut, join, or extend data cable in any way. Failure to follow will VOID warranty.**
4. If there is excess data cable left under the spa cabinet do not coil together with excess power cable. Be sure to keep excess cable separated by 150-300mm.



## 7. Spa Controller Heat Pump Settings

The SV Series heat pump interface seamlessly integrates the Eco Cube heat pump for efficient heating or cooling of the spa water. There is no setup process required, the SV spa controller will automatically detect the Eco Cube on bootup, disable the electric element and take control of the heat pump operation. All functions including heating / cooling / temperature adjustment / defrost cycles / freeze and over temp protection / diagnostics and monitoring are all controlled by the SV spa controller and the SV spa side touch pad.

There are two software settings for tailoring the heat pump operation:

- Heat Pump Operation Mode
- Heat Pump + Electric Element Boost

### 7.1 Heat Pump Operation Mode (H.PMP)

This setting determines the mode of operation. There are four possible choices:

H.PMP SETTING	DESCRIPTION
AUTO	Heating and Cooling
HEAT (default)	Heating only
COOL	Cooling only
OFF	Heat pump is disabled (spa reverts to using electric element)

*By default, H.PMP is set to HEAT to prevent heat pump from cooling if set temperature reduced.*

#### IMPORTANT

1. If H.PMP = HEAT and the set temperature is reduced, the heat pump will NOT engage to cool the water, the water will cool naturally over time.
2. If H.PMP = AUTO and the set temperature is reduced, the heat pump WILL engage to cool the water. Be careful using this setting in Winter as you will consume electricity to cool the water which may be an undesired outcome.
3. **Setting H.PMP = OFF does NOT stop the spa from heating.** It disables the heat pump and causes the spa controller to revert to using the electric element to heat the water.

#### 7.1.1 Adjusting Heat Pump Operation Mode (H.PMP)

The H.PMP – Heat pump operation mode setting is located within the General Settings menu of the SV series keypads. Whilst the SV spa control keypads differ slightly in appearance and button layout between models, they all share a common menu structure with control and adjustment carried out by logical UP, DOWN and OK button presses. The SmartTouch colour screen keypad is even more intuitive. Steps to adjust the H.PMP setting for each keypad type are detailed below:

### 7.1.1.1 Standard Touch Pads

	<p><b>Step 1:</b> Simultaneously press and hold UP + DOWN buttons (to access the General Settings menu) until display shows MODE or FILT then release.</p>
	<p><b>Step 2:</b> Press the UP button until display shows H.PMP (heat pump operation mode).</p>
	<p><b>Step 3:</b> Press the OK button to enter the H.PMP setting adjustment (display will show current setting).</p>

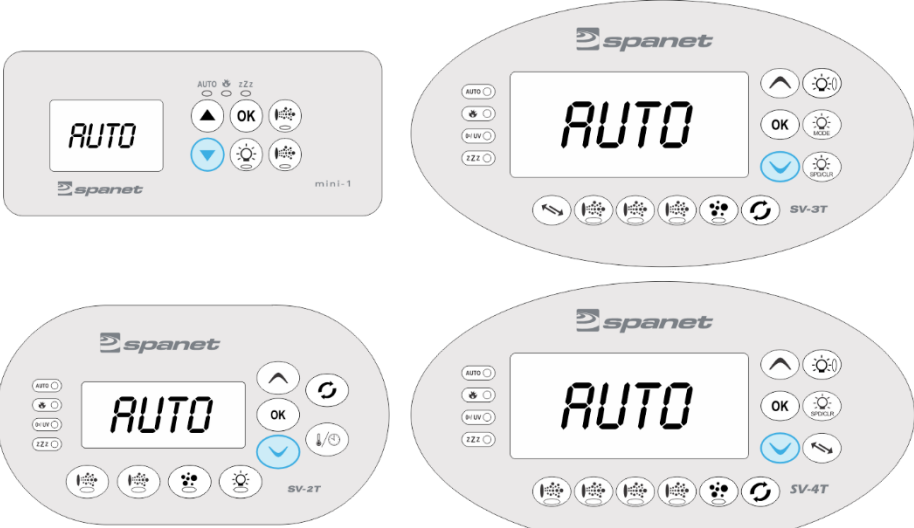
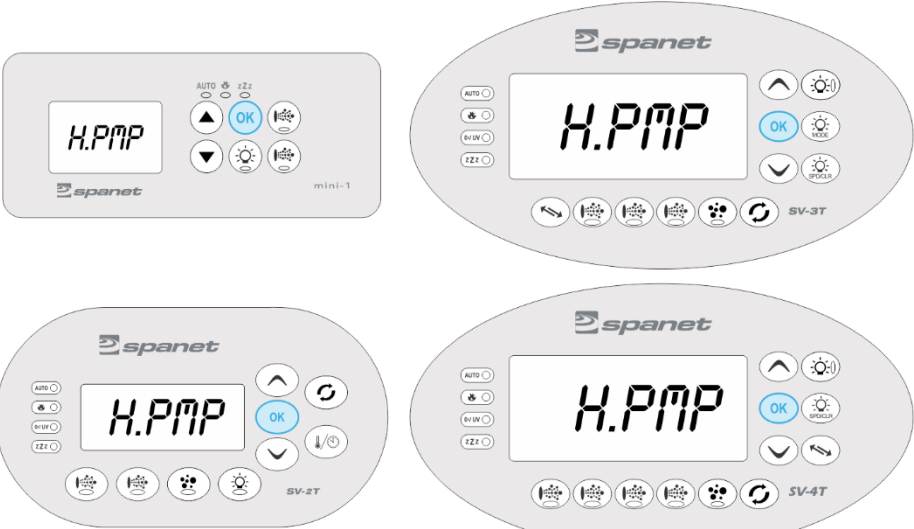
	<p><b>Step 4:</b> Use the UP or DOWN buttons to toggle between AUTO / HEAT / COOL / OFF.</p>
	<p><b>Step 5:</b> Press the OK button to confirm and save the setting and return to the General Settings menu.</p> <p><i>NOTE: If there is no further button press, after 10 seconds the menu will exit and return to default temperature display.</i></p>

### 7.1.1.2 SmartTouch Colour Touch Screen Keypads

	<p><b>Step 1:</b> Press on Cog icon to enter General Settings menu.</p>
---	---

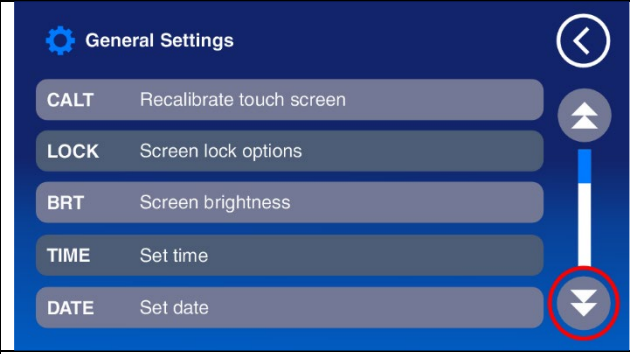
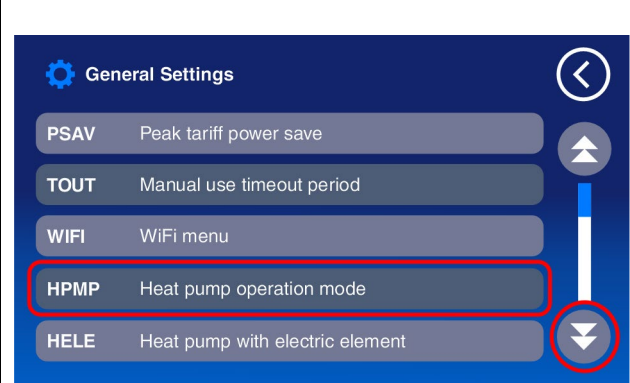
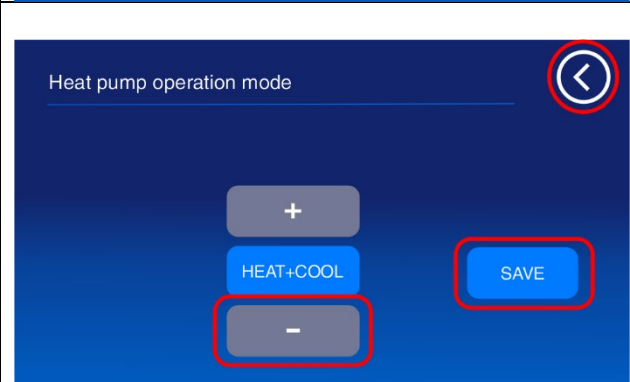
	<p><b>Step 2:</b> Scroll down towards bottom of General Settings menu.</p>
	<p><b>Step 3:</b> Select HPMP – Heat pump operation mode.</p>
	<p><b>Step 4:</b> Press on + or - button to toggle between HEAT+COOL / HEAT ONLY / COOL ONLY / DISABLED, then press SAVE, then use back arrow twice to return to home screen.</p>

## 7.2 Heat Pump with Electric Element Boost (H.ELE)

This setting enables the internal electric heating element of the SV Series spa control to operate in conjunction with the Eco Cube to boost heating output and reduce heating times. This feature gives control to spa owners to speed up reheating a large spa or swim spa which has been emptied/refilled, notwithstanding it will consume a lot more electricity to do so. There are two setting choices:

H.ELE SETTING	DESCRIPTION
OFF (default)	Heat pump only
ON	Heat pump + SV electric element

*By default, H.ELE is set to OFF to ensure the electric element is disabled and not used for heating when a heat pump is fitted to the spa, to maximise efficiency and reduce power consumption.*

### **⚠ VITAL**

**Only use H.ELE if the power circuit supplying the spa has sufficient power available to do so.** Depending on spa configuration and heater sizes, setting H.ELE=ON with plug-in spa pools may exceed the 10amp/15amp power limit, causing the circuit breaker to trip or a risk of fire.



## IMPORTANT

1. If there is NO heat pump fitted to the spa, setting H.ELE = OFF does NOT disable the internal electric heating element of the SV spa control. The setting only affects the electric element operation IF a heat pump is installed.
2. If H.ELE = ON the electric element of the SV spa control will ONLY operate in conjunction with the heat pump to boost heating IF the water temperature is 2°C or more BELOW the set temperature point OR the heat pump has been operating for more than 1 hour and the set temperature point has not been reached.
3. If the ambient temperature falls below the operational limit of the heat pump ( < -2°C ) the heat pump becomes latched in standby mode and the electric element of the SV spa control will be enabled regardless of the H.ELE setting. When the ambient temperature rises above -2°C, the heat pump returns to normal operation and the SV spa control will obey the selected H.ELE setting.

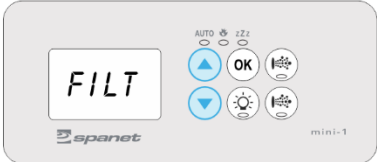

### 7.2.1 Adjusting Heat Pump + Electric Element Boost (H.ELE)

The H.ELE – Heat pump + electric element setting is also located within the General Settings menu of the SV series keypads. Steps to adjust the H.ELE setting for each keypad type are detailed below:

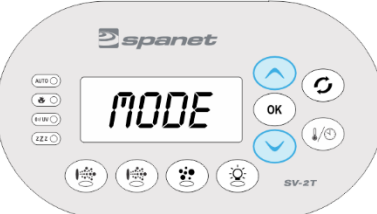
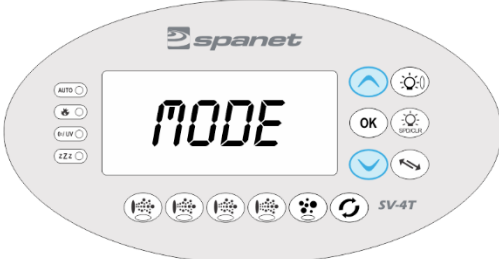
#### 7.2.1.1 Standard Touch Pads

		<b>Step 1:</b> Simultaneously press and hold UP + DOWN buttons (to access the General Settings menu) until display shows MODE or FILT then release.
		

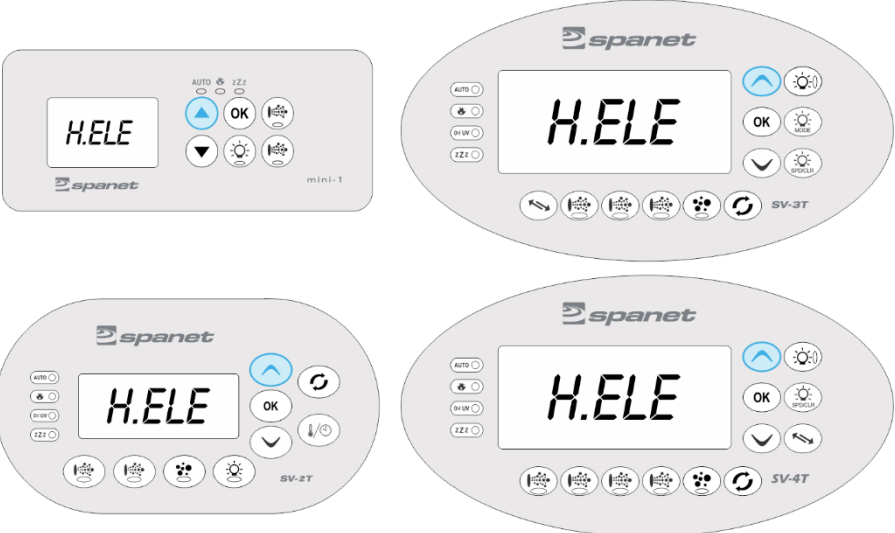
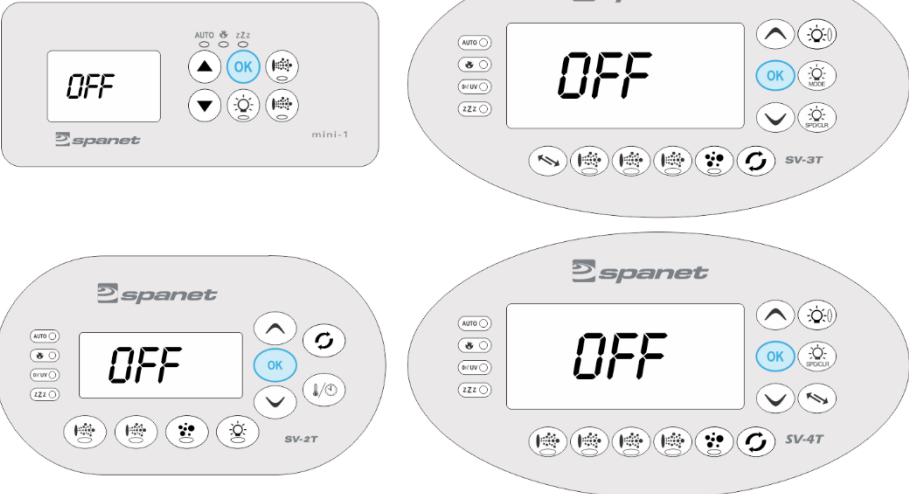

	<p><b>Step 2:</b> Press the UP button until display shows H.ELE (heat pump + electric element).</p>
	<p><b>Step 3:</b> Press the OK button to enter the H.ELE setting adjustment (display will show current setting).</p>
	<p><b>Step 4:</b> Use the UP or DOWN buttons to toggle between ON and OFF.</p>

	<p><b>Step 5:</b> Press the OK button to confirm and save the setting and return to the General Settings menu.</p> <p><i>NOTE: If there is no further button press, after 10 seconds the menu will exit and return to default temperature display.</i></p>
--	--

### 7.2.1.2 SmartTouch Colour Touch Screen Keypads

	<p><b>Step 1:</b> Press on Cog icon to enter General Settings menu.</p>
	<p><b>Step 2:</b> Scroll down towards bottom of General Settings menu.</p>
	<p><b>Step 3:</b> Select HELE – Heat pump with electric element.</p>

	<p><b>Step 4:</b> Press on + or - button to toggle between ENABLED / DISABLED, then press SAVE, then use back arrow twice to return to home screen.</p>
--	---

### 7.3 Set Temperature Adjustment and Range

The regulation of water temperature is governed by the settings within the SV Series spa controller. The set temperature point can easily be adjusted by pressing and holding either the UP or DOWN buttons on the SV spa side touch pad fitted to your spa.

The set temperature can be raised to a maximum of 41°C and lowered to a minimum of 5°C \*.

#### IMPORTANT

\* The minimum set temperature is defined by the SV Series spa control not the Eco Cube. Earlier SV spa control firmware had a minimum set temp of 10°C. If you are unable to reduce set temp lower than 10°C the firmware in the spa control will require updating. Seek assistance from your local spa reseller or technician.

#### RISK OF ICE BATHS

Health experts stress that people, **particularly those over 50**, should exercise caution before immersing into an ice bath due to **significant risk from hypothermia** (dangerous drop in body temperature) **or cold shock** (loss of breathing control, impaired thoughts, heart and blood pressure problems). **Recommend maximum length of ice bath is 10 minutes** and should be worked up to over time beginning with 60 second ice baths initially.

#### SPECIAL NOTE ON COOLING

The heat pump has principally been designed for cost efficient heating of your spa pool. Using refrigeration technology, the heat pump can operate in reverse cycle to cool the spa water as well. However, there are operating limits for the refrigerant and the cooling capacity is lower than the heating capacity. In extreme environmental weather conditions (ambient temperatures  $\geq 36^{\circ}\text{C}$ ) and where the spa water temperature  $\geq 34^{\circ}\text{C}$ , depending on heat pump location & environment (i.e. direct sunlight, undercover), nearby obstructions and air flow restrictions (i.e. fences, plants, walls) if the heat pump is used for COOLING, the refrigerant MAY exceed its working capacity and go into standby for 2 hours or shut down on high pressure error. To prevent this, **the heat pump should only be used for COOLING at times of day/night when ambient temperatures are lower, and prior to any extreme hot weather event.**

## 8. Winterizing Heat Pump

In areas where freezing conditions are brief and mostly an overnight occurrence, the freeze protection of the Eco Cube and SV spa control will prevent the exchange tank and pipework from freezing by engaging the filtration pump and circulating water every hour even if sleep timers are set. Freeze protection will override any sleep or power save timers that have been set in the SV spa control. Further information can be found in the "Safety / Protection Systems" section of this manual.

However, in areas where freezing conditions are prevalent and sustained, where the ambient temperature remains consistently below the -2°C operational limit of the Eco Cube, or the spa is to be turned OFF during the winter period, in advance of any freeze event, all water MUST be removed from the entire heat pump water circuit including heat exchanger. Freezing of the unit will severely damage the heat exchanger and other components due to water/ice expansion. Damage resulting from a failure to properly winterize is NOT covered under the heat pump product warranty.

Winterizing is a procedure that prepares your heat pump for freezing conditions. Please follow the directions below:

### 8.1 Preparing for Freezing Conditions

Preparing your Eco Cube for freezing conditions is a two-stage process. The first step involves disabling the heat pump via the SV spa controller software settings. The second step involves isolating the water flow from the heat pump (if the spa is to remain on) and/or draining the water from the heat exchange tank and pipework (to prevent ice expansion damage). This two-stage process is explained further below:

#### 8.1.1 Disable Heat Pump in SV Spa Controller Settings

1. Enter the SV spa control General Settings Menu.
2. Locate the H.PMP – Heat Pump Operation Mode setting.
3. Adjust H.PMP=OFF (OFF=heat pump is disabled)

#### IMPORTANT

1. The process of adjusting the H.PMP setting on both standard touch pads and SmartTouch colour touch screen keypads is detailed in the "Spa Controller Heat Pump Settings" section of this manual.
2. If H.PMP=OFF the heat pump is disabled and will not be used to heat the spa. There is no need to disconnect the power or data cables from the SV spa controller. The spa control's internal electric element will automatically be used for heating instead.

### 8.1.2 Isolate Water Flow to Heat Pump (to continue using spa)

Adjusting the valves on the spa to isolate water flow to the heat pump is only required where the heat pump is to be Winterized but the spa will continue to be used. If the whole spa is being emptied and not used during the Winter season it is not necessary to follow these steps.

1. Switch OFF mains power to spa.
2. Adjust isolation and bypass valves to close water supply to the heat pump and keep water circulating within the spa. This is achieved by:
  - a. Adjust isolation valves 1 & 2 to 100% closed.
  - b. Adjust bypass valve 3 to 100% open.

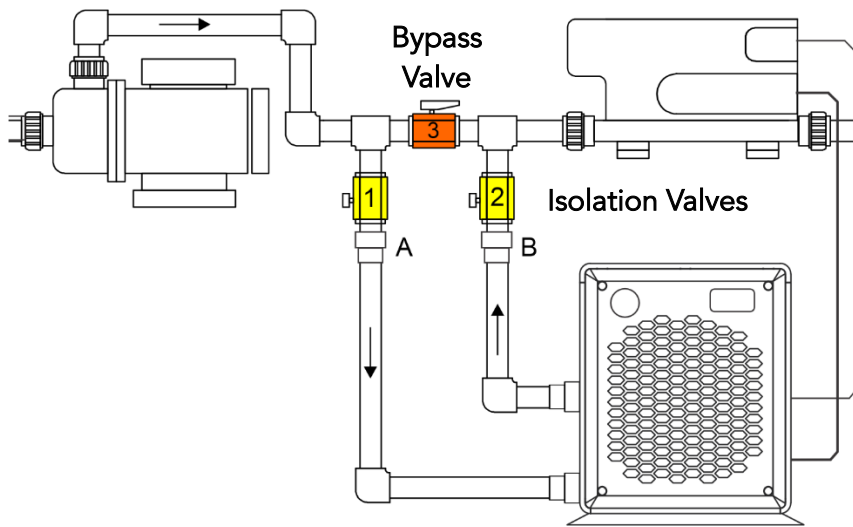

#### **⚠ WARNING**

The water flow can only be isolated, and spa continued to be used, if the spa has been fitted with isolation and bypass valves during installation. If the heat pump has been plumbed directly without valves the complete spa and heat pump must be emptied for the freezing Winter.

### 8.1.3 Drain Water from Heat Pump and Pipework

Drain water from the heat exchanger and inlet and outlet pipes by disconnecting the inlet and outlet hose adapters from the Eco Cube. It may be necessary to unscrew the hose clamp and remove the pipe from the adapters to do this.

Once the water has been drained it is recommended to flush the inside of the heat exchanger with a hose and drain the unit again.

Refit hose adapters, pipe, and clamps to the outlet ports to prevent lost parts, insect / debris ingress and degradation to the pipe.

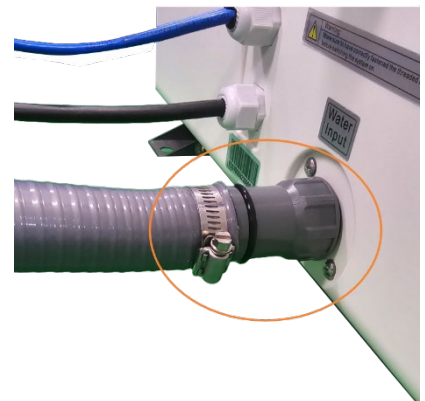

## **WARNING**

If the whole spa is being shut down for Winter, the spa side cabinet panel should be removed and couplings loosened on both the filtration pump and spa controller to completely drain pipe work of water to prevent freezing and ice damage.

## 8.2 Prepare to Restart Heat Pump after Winter

1. If the spa has continued to be used during Winter, switch OFF mains power to spa.
2. Check inlet and outlet hose adapters, pipe and hose clamps are fitted correctly and tightened securely on Eco Cube to prevent water leaks.
3. Adjust isolation and bypass valves to return water supply through heat pump and back to spa
  - a. Adjust isolation valves 1 & 2 to 100% open.
  - b. Adjust bypass valve 3 to closed position defined on Plumbing Diagram page and type of filtration pump installed (100% closed for circs, 50% closed / 50% open for 2-speed)
4. Remove filters from spa and fill spa with water through filter box area to prevent air locks.
5. Once the spa has reached the water fill line, remove spa side cabinet panel, locate spa controller heater and loosen coupling on return side of the plumbing to bleed air from pipework. Once the air has escaped and there is a constant stream of water, re-tighten the coupling sufficiently.
6. Supply power to the spa and operate filtration pump to purge all remaining air from the heat pump and pipework. If you cannot see the water returning to the spa, turn the power OFF and attempt to bleed more air from the pipework by loosening the return coupling on the spa control heater and/or at the filtration pump discharge coupling if required. Be sure to re-tighten all couplings sufficiently after bleeding. Operate the pump for a period and check for drips and leak. Take corrective action where required.

### 8.2.1 Enable Heat Pump in SV Spa Controller Settings

1. Enter the SV spa control General Settings Menu.
2. Locate the H.PMP – Heat Pump Operation Mode setting.
3. Adjust H.PMP=HEAT or AUTO (HEAT=Heating only, AUTO=Heating and Cooling)

**NOTE:** The process of adjusting the H.PMP setting on both standard touch pads and SmartTouch colour touch screen keypads is detailed in the “Spa Controller Heat Pump Settings” section of this manual

## **WARNING**

**FREEZE DAMAGE IS NOT COVERED UNDER PRODUCT WARRANTY.**



## 9. Safety / Protection Systems

SV Heat pumps are equipped with the following safety protection systems:

<b>Water flow switch</b>	<p>The heat pump is fitted with a flow switch to prevent the heat pump from operating and overheating the water in the heat exchange tank if there is insufficient or no water flow through the heat pump. The flow switch must close within 30 seconds of the heat pump starting to prevent a "HEAT PUMP FLOW" error.</p>
<b>Refrigerant gas high-pressure protection</b>	<p>The high-pressure protection makes sure the heat pump is not damaged in case of over pressurisation of the gas due to insufficient water flow or high ambient temperatures.</p>
<b>Refrigerant gas low-pressure protection</b>	<p>The low-pressure protection identifies when refrigerant has escaped from the conduits and the unit cannot be kept running.</p>
<b>Compressor over temperature protection</b>	<p>This 100°C thermal cut out switch protects the compressor from overheating.</p>
<b>Automatic defrost control</b>	<p>When the air is humid and cold, ice can form on the evaporator. In such situations, a thin layer of ice appears that will grow increasingly bigger if the heat pump is running. When the temperature of the evaporator has become too low, automatic defrost control will be activated, which will reverse the heat pump cycle so that hot refrigerant gas is sent through the evaporator for a brief period to defrost it. During a defrost cycle the ice will melt and generally will create steam.</p>
<b>Anti-freeze protection during winter</b>	<p>For freeze protection we have multiple protection methods in place:</p> <p>If the heat pump ambient sensor detects temperatures lower than 3°C the 40W defrost element is switched on inside the heat pump to help keep the condenser and heat exchanger warm. This element will switch off once the ambient temperature rises above 3°C.</p> <p>If the heat pump ambient sensor detects temperatures of 1°C or lower the filtration pump is switched on and will run for 5 minutes every hour until the ambient temperature rises above 1°C (earlier spa control firmware ran the filter pump continuously). Sleep and power save timers are ignored. Freeze protection overrides any programmed timers or operating modes.</p>

## 10. Maintenance

The Eco Cube heat pump is a self-contained unit which, if installed as per the guidelines outlined in this manual, should provide years of trouble-free operation with next to no maintenance.

### 10.1 Evaporator Cleaning

The evaporator does not require any special maintenance, except when it is clogged by dirt or any other debris (i.e. tree leaves, pet fur, plastic rubbish). Cleaning is by washing with detergent and water at low pressure, and then rinsing with clean water.

#### **⚠ WARNING**

1. Before cleaning, make sure the spa pool and heat pump are powered OFF.
2. Inside of heat pump should not be cleaned, unless by a qualified person.
3. Do not use gasoline, benzene, or harsh chemicals to clean the heat pump. And do not spray with insecticide, the unit may be damaged. The cleanser specially made for air conditioner cleaning is recommended.
4. Spray air conditioner cleanser into the evaporator, let the cleanser sit for 5~8 minutes.
5. Then spray the evaporator with clean water.
6. An old hairbrush works well for brushing surface dirt and lint off the fins. Brush in the same direction as the slots between the fins so the bristles go between the fins.
7. After cleaning, use a soft and dry cloth to dry off excess water from the unit

### 10.2 Refrigerant Charging

Refrigerant is very stable and should not degrade or break down even under severe operating conditions. It is not necessary to service or charge the heat pump with refrigerant unless there has been a refrigerant leak, which would cause an unexpected loss of performance or low-pressure error. If the unit has a leak in the sealed refrigeration system, please contact a refrigeration mechanic or qualified repairer. They will locate the leakage and repair before charging with more refrigerant.

#### **⚠ VITAL**

Refrigerant system repair and charging MUST be performed by a qualified person.

## 11. Troubleshooting

Should a major fault occur the SV spa controller will disable the heat pump (heating will stop) and the spa side touch pad will display a scrolling error message every 30 seconds. Refer to error codes section of this manual for further advice. However, if the spa control is not displaying any errors but the Eco Cube is not working as expected, please refer to the troubleshooting tips below.

### VITAL

There are no user serviceable parts inside the heat pump. If a major error occurs, please contact your spa reseller, service technician or a licensed professional for service.

PROBLEM	ACTION
WATER LEAKING FROM BASE OF UNIT	<p>If there is humidity in the air when the heat pump is running, condensation will form on the evaporator as part of the heat exchange process. The higher the humidity the more condensation created. It is not uncommon for the heat pump to produce many litres of condensation. The condensation will collect in the base of the heat pump and exit via the drain hole under the unit. If you are concerned about water pooling under your Eco Cube, check the installer has fitted the condensation drain elbow then attach a hose to direct the run-off to a suitable location. If the heat pump was leaking the spa water level would drop every day. If there is no drop in water level the water is from condensation not a physical leak. This can be confirmed by disabling the heat pump, leaving it off and seeing if the water dries up. If not check inlet/outlet fittings and flow switch are screwed tightly onto heat exchanger.</p>
"HEAT PUMP FLOW" ERROR	<p>The flow switch must close within 30 seconds of filtration pump operation. If a heat pump flow error occurs there is insufficient or no water flow to close the flow switch. Once a flow error has occurred, even if water flow has been re-established, mains power to the SV spa control must be reset before the heat pump will operate again.</p> <p><b>New installations:</b></p> <ul style="list-style-type: none"> <li>• Check that isolation and bypass valves have been positioned correctly as per the plumbing diagram.</li> <li>• Check water level is OK and confirm water is flowing freely into filter box.</li> <li>• Check there is adequate water flow returning to the spa. If there is no flow, attempt to bleed potential air locks from pipework.</li> <li>• Inspect pipe work and follow flow direction to ensure water is flowing out of the spa into the bottom inlet pipe on the heat pump, flowing out of the top outlet pipe on the heat pump and returning to the spa. If heat pump has been plumbed in reverse direction, correct plumbing or rotate direction of flow switch 180 degrees.</li> <li>• Check filtration pump is working, if not troubleshoot and take corrective action to resolve.</li> </ul> <p><b>Existing installs:</b></p> <ul style="list-style-type: none"> <li>• Check the spa water level is OK, refill if necessary.</li> <li>• Clean or replace filter cartridges.</li> <li>• If the spa has just been emptied/refilled, bleed air locks from pipework.</li> <li>• Check filtration pump is working OK and has not seized or stalled.</li> </ul>

PROBLEM	ACTION
<p><b>NO HEAT PUMP OPERATION</b></p>	<ul style="list-style-type: none"> <li>• Check SV spa controller settings. Confirm the H.PMP setting is not set to a mode which could prevent the heat pump from running.</li> <li>• Confirm ambient air temperature is within operational limits.</li> <li>• Check there is no hammer and spanner error symbol on the display. If error symbol is present, wait for the error code to scroll every 30 seconds (touch screen displays will scroll any heat pump error across the screen underneath the temperature) and take corrective action for that error accordingly.</li> <li>• Check that the heat pump power source is OK. <ul style="list-style-type: none"> <li>○ If connected to the SV spa controller, ensure the power cable is firmly connected to a socket labelled 230V outlet and not a Pump outlet.</li> <li>○ If connected to a separate power circuit check the breaker is ON and RCD safety switch has not tripped.</li> </ul> </li> <li>• Check power and data cables for signs of damage. Replace cables if damaged.</li> <li>• Inspect internal heat pump circuit board for damage or blown fuse (NOTE: Ensure power is isolated and turned OFF before inspecting heat pump. This work should be performed by a qualified person).</li> </ul>
<p><b>THERMAL CUT OUT ERRORS</b></p>	<ul style="list-style-type: none"> <li>• Water flow is insufficient, check for poor filtration pump flow performance.</li> <li>• Confirm ambient air temperatures are within operational limits.</li> <li>• Confirm heat pump air space is clear and not obstructed by vegetation or objects.</li> </ul>
<p><b>POOR HEATING PERFORMANCE</b></p>	<ul style="list-style-type: none"> <li>• Heat pump appears to be working but there is no or insufficient heating.</li> <li>• First check the ambient temperature, water temperature, volume of the spa and estimate the related heating capacity and expected temperature rise per hour.</li> <li>• Check if the heat pump has a ventilation obstacle and remove obstruction.</li> <li>• Confirm exhaust fan is working.</li> <li>• Check the general power supply is correct and amperage draw from heat pump is as expected. If no, check compressor capacitor as it may be damaged and require replacing.</li> <li>• Check for excessive build-up of ice on the evaporator. If present, contact your spa reseller or technician to assist with adjustment of defrost cycle values and/or temperature sensors.</li> </ul>

## 12. Heat Pump Error Codes

If a heat pump fault condition is detected the standard SV touch pads will display a hammer and spanner fault icon and will scroll an error message across the LCD every 30 seconds. For SmartTouch colour touch pads the heat pump error message will continuously scroll across the display in blue writing. When an error condition occurs, the heat pump is disabled, and the error condition will not clear until the mains power to the SV spa control is reset. The spa will continue to filter however heating will not occur until the issue with the heat pump is resolved.

### IMPORTANT

The heat pump warning message will continue to scroll every 30~60 seconds, and the heat pump will remain disabled until the mains power is turned OFF and back ON again.

A list of the fault conditions and warning messages are detailed below for reference.

ERROR MESSAGE	DESCRIPTION
HEAT PUMP AMB	Ambient temperature sensor error
HEAT PUMP COND	Condenser (Evaporator) temperature sensor error
HEAT PUMP FLOW	Water flow not detected
HEAT PUMP LOW P	Compressor low pressure switch open
HEAT PUMP HIGH P	Compressor high pressure switch open
HEAT PUMP COMP	Compressor thermal cut out open
HEAT PUMP EXCH	Heat exchanger thermal cut out open

Trouble shooting tips for each error code are detailed below for reference:

ERROR	PROBLEM / ACTION
HEAT PUMP AMB	<ul style="list-style-type: none"> <li>No signal from ambient temperature sensor, or signal is corrupted.</li> <li>Check ambient sensor is connected to heat pump circuit board securely.</li> <li>Inspect data cable for damage and check data cable securely connected to SV spa control EXP2 socket. The data cable is the most likely cause.</li> <li>Disconnect/reconnect data cable from SV spa control and reset mains power.</li> <li>Replace data cable if problem unresolved (use double shielded CAT5/CAT6 Ethernet cable)</li> </ul>
HEAT PUMP COND	<ul style="list-style-type: none"> <li>No signal from condenser temperature sensor, or signal is corrupted.</li> <li>Check condenser sensor is connected to heat pump circuit board securely.</li> <li>Inspect data cable for damage and check data cable securely connected to SV spa control EXP2 socket. The data cable is the most likely cause.</li> <li>Disconnect/reconnect data cable from SV spa control and reset mains power.</li> <li>Replace data cable if problem unresolved (use double shielded CAT5/CAT6 Ethernet cable)</li> </ul>
HEAT PUMP FLOW	<ul style="list-style-type: none"> <li>No or insufficient water flow passing through heat pump.</li> <li>Refer to suggested solutions within Troubleshooting section of this manual.</li> </ul>

ERROR	PROBLEM / ACTION
<b>HEAT PUMP LOW P</b>	<ul style="list-style-type: none"> <li>• No signal from low pressure switch or insufficient refrigerant gas charge.</li> <li>• Check low pressure switch is securely connected to heat pump circuit board.</li> <li>• Check refrigerant level (if pressure gauge fitted), if low have heat pump checked by a refrigeration mechanic.</li> </ul>
<b>HEAT PUMP HIGH P</b>	<ul style="list-style-type: none"> <li>• No signal from high pressure switch or refrigerant pressure too high.</li> <li>• Check high pressure switch is securely connected to heat pump circuit board.</li> <li>• Confirm water flow is sufficient and clean or replace filter cartridges.</li> <li>• Confirm ambient air and water temperatures are within operational limits.</li> <li>• Confirm exhaust fan is working.</li> </ul> <p><b>NOTE:</b> In extreme environmental weather conditions (ambient temperatures <math>\geq 36^{\circ}\text{C}</math>) and where the spa water temperature <math>\geq 34^{\circ}\text{C}</math>, depending on heat pump location &amp; environment (i.e. direct sunlight, undercover), nearby obstructions and air flow restrictions (i.e. fences, plants, walls) if the heat pump is used for cooling, the refrigerant may exceed its working capacity and go into standby for 2 hours or shut down on high pressure error. To prevent this, the heat pump should only be used for cooling at times of day/night when ambient temperatures are lower, and prior to any extreme hot weather event.</p>
<b>HEAT PUMP COMP</b>	<ul style="list-style-type: none"> <li>• Compressor exhaust gas has exceeded <math>100^{\circ}\text{C}</math> working temperature.</li> <li>• Confirm ambient air and water temperatures are within operational limits.</li> <li>• Confirm exhaust fan is working.</li> <li>• Confirm water flow is sufficient and clean or replace filter cartridges.</li> <li>• Turn mains power OFF, leave heat pump for 1 hour for compressor to cool and then test again.</li> <li>• Inspect data cable for damage and check data cable securely connected to SV spa control EXP2 socket.</li> <li>• Latched compressor relay on circuit board =&gt; disable heat pump operation and check that compressor turns off, if not replace circuit board.</li> <li>• Check for refrigeration leakage (if pressure gauge fitted) otherwise engage a refrigeration mechanic to check for leakage and repair.</li> </ul>
<b>HEAT PUMP EXCH</b>	<ul style="list-style-type: none"> <li>• Water temperature in heat exchange tank has exceeded <math>50^{\circ}\text{C}</math> or thermal cut out signal is corrupted.</li> <li>• Check spa water level and ensure water flow from filtration pump is sufficient.</li> <li>• Clean or replace spa filter cartridges to improve water flow.</li> <li>• Inspect data cable for damage and check data cable securely connected to SV spa control EXP2 socket.</li> <li>• Titanium coil inside exchange tank is coated in chemical or calcium residue and cannot dissipate heat =&gt; disconnect heat pump and flush exchange tank.</li> <li>• Latched compressor relay on circuit board =&gt; disable heat pump operation and check that compressor turns off, if not replace circuit board</li> </ul>

If after following the troubleshooting tips and resetting mains power the fault condition persists, please contact your spa reseller, and report the warning message/error code that is shown.



# 13. Wiring Diagram

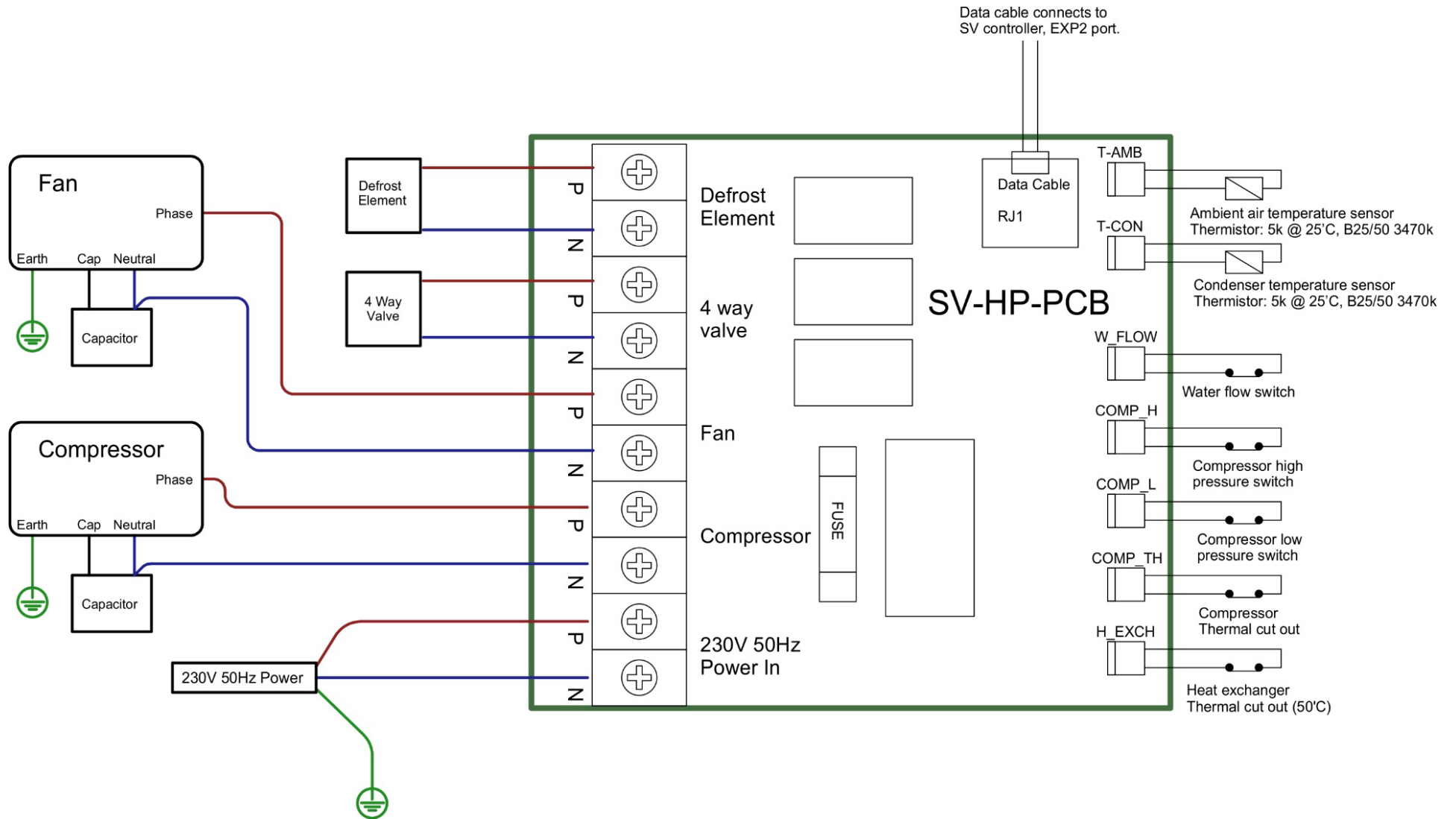

**NOTE :** This diagram is correct at the time of publication, manufacturing changes could lead to modifications. Always refer to the diagram supplied with the heat pump.

## 14. R290 Service Operations



This heat pump contains a flammable refrigerant R290. Any intervention on the refrigerant circuit is prohibited without a valid authorization. Before working on the refrigerant circuit, the following precautions are necessary for safe work.

Only persons authorized by an accredited agency certifying their competence to handle refrigerants in compliance with sector legislation should work on refrigerant circuits.

Servicing shall be performed only as recommended by the manufacturer.

Any person who is involved with working on or breaking into a refrigerant circuit should hold a current valid certificate from an industry-accredited assessment authority, which authorises their competence to handle refrigerants safely in accordance with an industry recognised assessment specification.

Servicing shall only be performed as recommended by the equipment manufacturer. Maintenance and repair requiring the assistance of other skilled personnel shall be carried out under the supervision of the person competent in the use of flammable refrigerants.

### 1. Checks to the area

Prior to beginning work on systems containing flammable refrigerants, safety checks are necessary to ensure that the risk of ignition is minimised. For repair to the refrigerating system, the following precautions shall be complied with prior to conducting work on the system.

### 2. Work procedure

The work must be carried out according to a controlled procedure, in order to minimize the risk of presence of flammable gases or vapors during the execution of the works.

### 3. General work area

All persons in the area must be informed of the nature of the work in progress. Avoid working in a confined area. The area around the work area should be divided, secured and special attention should be paid to nearby sources of flame or heat.

### 4. Verification of the presence of refrigerant

The area should be checked with a suitable refrigerant detector before and during work to ensure that there is no potentially flammable gas. Make sure that the leak detection equipment used is suitable for flammable refrigerants, i.e. it does not produce sparks, is properly sealed or has internal safety.

### 5. Presence of fire extinguisher

If hot work is to be performed on the refrigeration equipment or any associated part, appropriate fire extinguishing equipment must be available. Install a dry powder or CO<sub>2</sub> fire extinguisher near the work area.

## 6. No source of flame, heat or spark

It is totally forbidden to use a source of heat, flame or spark in the direct vicinity of one or more parts or pipes containing or having contained a flammable refrigerant. All sources of ignition, including smoking, must be sufficiently far from the place of installation, repair, removal and disposal, during which time a flammable refrigerant may be released into the surrounding area. Before starting work, the environment of the equipment should be checked to ensure that there is no risk of flammability. «No smoking» signs must be posted.

## 7. Ventilated area

Make sure the area is in the open air or is properly ventilated before working on the system or performing hot work. Some ventilation must be maintained during the duration of the work.

## 8. Controls of refrigeration equipment

When electrical components are replaced, they must be suitable for the intended purpose and the appropriate specifications. Only the parts of the manufacturer can be used. If in doubt, consult the technical service of the manufacturer.

The following controls should be applied to installations using flammable refrigerants:

- The size of the load is in accordance with the size of the room in which the rooms containing the refrigerant are installed;
- Ventilation and air vents work properly and are not obstructed;
- If an indirect refrigeration circuit is used, the secondary circuit must also be checked.
- The marking on the equipment remains visible and legible. Illegible marks and signs must be corrected;
- Refrigeration pipes or components are installed in a position where they are unlikely to be exposed to a substance that could corrode components containing refrigerant

## 9. Verification of electrical appliances

Repair and maintenance of electrical components must include initial safety checks and component inspection procedures. If there is a defect that could compromise safety, no power supply should be connected to the circuit until the problem is resolved.

Initial security checks must include:

- That the capacitors are discharged: this must be done in a safe way to avoid the possibility of sparks;
- No electrical components or wiring are exposed during loading, recovery or purging of the refrigerant gas system;
- There is continuity of grounding.

## 10. Initial safety checks shall include

- that capacitors are discharged: this shall be done in a safe manner to avoid possibility of sparking;

- that no live electrical components and wiring are exposed while charging, recovering or purging the system;
- that there is continuity of earth bonding.

### **11. Repairs to sealed components**

During repairs to sealed component, all electrical supplies shall be disconnected from the equipment being worked upon prior to any removal of sealed covers, etc. If it is absolutely necessary to have an electrical supply to equipment during servicing, then a permanently operating form of leak detection shall be located at the most critical point to warn of a potentially hazardous situation.

Particular attention shall be paid to the following to ensure that by working on electrical components, the casing is not altered in such a way that the level of protection is affected. This shall include damage to cables, excessive number of connections, terminals not made to original specification, damage to seals, incorrect fitting of glands, etc.

Ensure that apparatus is mounted securely.

Ensure that seals or sealing materials have not degraded such that they no longer serve the purpose of preventing the ingress of flammable atmospheres. Replacement parts shall be in accordance with the manufacturer's specifications.

**NOTE** The use of silicon sealant may inhibit the effectiveness of some types of leak detection equipment. Intrinsically safe components do not have to be isolated prior to working on them.

### **12. Repair to intrinsically safe components**

Do not apply any permanent inductive or capacitance loads to the circuit without ensuring that this will not exceed the permissible voltage and current permitted for the equipment in use.

Intrinsically safe components are the only types that can be worked on while live in the presence of a flammable atmosphere. The test apparatus shall be at the correct rating.

Replace components only with parts specified by the manufacturer. Other parts may result in the ignition of refrigerant in the atmosphere from a leak.

### **13. Cabling**

Check that cabling will not be subject to wear, corrosion, excessive pressure, vibration, sharp edges or any other adverse environmental effects. The check shall also take into account the effects of ageing or continual vibration from sources such as compressors or fans.

### **14. Detection of flammable refrigerants**

Under no circumstances shall potential sources of ignition be used in the searching for or detection of refrigerant leaks. A halide torch (or any other detector using a naked flame) shall not be used.

### **15. Leak detection methods**

The following leak detection methods are deemed acceptable for systems containing flammable refrigerants.

Electronic leak detectors shall be used to detect flammable refrigerants, but the sensitivity may not be adequate, or may need re-calibration. (Detection equipment shall be calibrated in a refrigerant-free area. Ensure that the detector is not a potential source of ignition and is suitable for the refrigerant used. Leak detection equipment shall be set at a percentage of the LFL of the refrigerant and shall be calibrated to the refrigerant employed and the appropriate percentage of gas (25% maximum) is confirmed.

Leak detection fluids are suitable for use with most refrigerants but the use of detergents containing chlorine shall be avoided as the chlorine may react with the refrigerant and corrode the copper pipe-work.

If a leak is suspected, all naked flames shall be removed/extinguished.

If a leakage of refrigerant is found which requires brazing, all of the refrigerant shall be recovered from the system, or isolated (by means of shut off valves) in a part of the system remote from the leak. Oxygen free nitrogen (OFN) shall then be purged through the system both before and during the brazing process.

## **16. Removal and evacuation**

When breaking into the refrigerant circuit to make repairs - or for any other purpose - conventional procedures shall be used. However, it is important that best practice is followed since flammability is a consideration. The following procedure shall be adhered to:

1. remove refrigerant;
2. purge the circuit with inert gas;
3. evacuate;
4. purge again with inert gas;
5. open the circuit by cutting or brazing.

The refrigerant charge shall be recovered into the correct recovery cylinders. The system shall be "flushed" with OFN to render the unit safe. This process may need to be repeated several times. Compressed air or oxygen shall not be used for this task.

Flushing shall be achieved by breaking the vacuum in the system with OFN and continuing to fill until the working pressure is achieved, then venting to atmosphere, and finally pulling down to a vacuum. This process shall be repeated until no refrigerant is within the system. When the final OFN charge is used, the system shall be vented down to atmospheric pressure to enable work to take place. This operation is absolutely vital if brazing operations on the pipe - work are to take place.

Ensure that the outlet for the vacuum pump is not close to any ignition sources and there is ventilation available.

## **17. Charging procedures**

In addition to conventional charging procedures, the following requirements shall be followed.

- Ensure that contamination of different refrigerant does not occur when using charging equipment. Hoses or lines shall be as short as possible to minimize the amount of refrigerant contained in them.
- Cylinders shall be kept upright.
- Ensure that the refrigeration system is earthed prior to charging the system with refrigerant.
- Label the system when charging is complete (if not already).
- Extreme care shall be taken not to overfill the refrigeration system.

Prior to recharging the system it shall be pressure tested with OFN. The system shall be tested on completion of charging but prior to commissioning. A follow up leak test shall be carried out prior to leaving the site.

### **18. Decommissioning**

Before carrying out this procedure, it is essential that the technician is completely familiar with the equipment and all its detail. It is recommended good practice that all refrigerants are recovered safely. Prior to the task being carried out, an oil and refrigerant sample shall be taken in case analysis is required prior to re-use of reclaimed refrigerant. It is essential that electrical power is available before the task is commenced.

1. Become familiar with the equipment and its operation.
2. Isolate system electrically.
3. Before attempting the procedure ensure that.
  - a) mechanical handling equipment is available, if required, for handling refrigerant cylinders:
  - b) all personal protective equipment is available and being used correctly
  - c) the recovery process is supervised at all times by a competent person;
  - d) recovery equipment and cylinders conform to the appropriate standards.
4. Pump down refrigerant system. if possible.
5. If a vacuum is not possible, make a manifold so that refrigerant can be removed from various parts of the system.
6. Make sure that cylinder is situated on the scales before recovery takes place.
7. Start the recovery machine and operate in accordance with manufacturers instructions.
8. Do not overfill cylinders. (No more than 80 volume liquid charge).
9. Do not exceed the maximum working pressure of the cylinder, even temporarily.
10. When the cylinders have been filled correctly and the process completed, make sure that the cylinders and the equipment are removed from site promptly and all isolation valves on the equipment are closed off.



11. Recovered refrigerant shall not be charged into another refrigeration system unless it has been cleaned and checked.

## **19. Labelling**

Equipment shall be labelled stating that it has been de-commissioned and emptied of refrigerant. The label shall be dated and signed. Ensure that there are labels on the equipment stating the equipment contains flammable refrigerant.

## **20. Recovery**

When removing refrigerant from a system, either for the servicing or decommissioning, it is recommended good practice that all refrigerants are removed safely.

When transferring refrigerant into cylinders, ensure that only appropriate refrigerant recovery cylinders are employed. Ensure that the correct number of cylinders for holding the total system charge are available. All cylinders to be used are designate for the recovered refrigerant and labeled for that refrigerant (i.e. special cylinders for the recovery of Refrigerant). Cylinders shall be complete with pressure relief valve and associated shut-off valves in good working order. Empty recovery cylinders are evacuated and, if possible, cooled before recovery occurs.

The recovery equipment shall be in good working order with a set of instructions concerning the equipment that is at hand and shall be suitable for the recovery of flammable refrigerants In addition, a set of calibrated weighing scales shall be available and in good working order Hoses shall be complete with leak-free disconnect couplings and in good condition. Before using the recovery machine, check that it is in satisfactory working order, has been properly maintained and that any associated electrical components are sealed to prevent ignition in the event of a refrigerant release. Consult manufacturer if in doubt.

The recovered refrigerant shall be returned to the refrigerant supplier in the correct recovery cylinder, and the relevant Waste Transfer Note arranged. Do not mix refrigerants in recovery nits and especially not in cylinders.

If compressors or compressor oils are to be removed, ensure that they have been evacuated to an acceptable level to make certain that flammable refrigerant does not remain within the lubricant. The evacuation process shall be carried out prior to returning the compressor to the suppliers. Only electric heating to the compressor body shall be employed to accelerate this process. When oil is drained from a system, it shall be carried out safety.

## Contact Us

### Spa Net Pty Ltd

Unit 1

103 Mulgrave Road

Mulgrave NSW 2756

Australia

P | +61 2 4587 7766

E | [service@spanet.com.au](mailto:service@spanet.com.au)