



INSTALLATION & MAINTENANCE MANUAL

SHP-60 SHP-80
SHP-100 SHP-140
SHP-170 SHP-190

Table of Contents

1. Safety precautions	3
2. Technical description	5
2.1 Specifications	5
3. Touch pad operation	5
3.1 LCD display and touch pad control	5
3.2 Set the operation parameter	7
3.3 Powering the unit	9
3.4 Selecting the operation mode	10
3.5 Setting the temperature	10
3.6 Check the current temperature	11
3.7 Setting the time	12
3.8 Timer ON/OFF	12
3.9 Coercive defrosting	12
3.10 Key lock	12
4. Safety and control systems	13
4.1 Water flow switch	13
4.2 Refrigerant gas high-and-low pressure protection	13
4.3 Overheating protection on the compressor	13
4.4 Automatic defrost control	13
4.5 Anti-frost protection during winter	13
4.5.1 First anti-frost protection	13
4.5.2 Second anti-frost protection	13
4.6 Three phase protection	14
5. Installation	14
5.1 Recommended air flow requirements	14
5.2 Location of the unit	15
5.3 Installation of water	16
5.4 Heat pump plumbing diagram	17
5.5 Electric connection	18
6. Water flow and refrigerating circuit pressure	18
7. Problematic environmental conditions	19
8. Maintenance and inspection	19
8.1 Maintenance	19
8.2 Troubleshooting guide	21
8.3 Overview of possible error codes displayed on the screen	21

1. Safety Precautions

VITAL: Electrical power must be switched off before starting any work on heat pump. **DO NOT** attempt to modify the internal configuration of the heat pump. Read the entire installation manual before use or service.

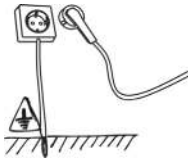

The unit must be earthed to avoid any risks caused by insulation defects. The heat pump will be earthed via the pre-installed power cable which connects to the spa control. If a different power source is used, ensure heat pump is connected to earth.

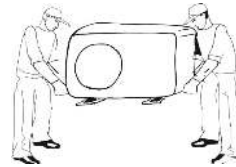

The installation, commissioning and maintenance of these machines should be performed by qualified personnel having a good knowledge of standards and local regulations, as well as experience with this type of equipment.



You can clean the evaporator by washing with detergent and water at low pressure, and then rinsing with clean water.

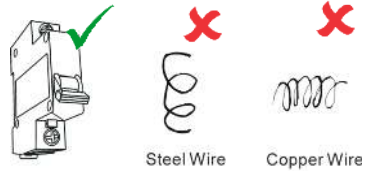

It is the responsibility of the installer to ensure circuit breaker protection, considering the heat pump capacity. The heat pump should also be supplied through a residual current device (RCD) having a rated residual operating current not exceeding 30mA.

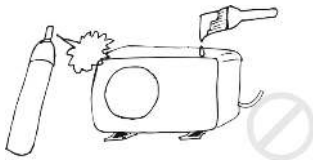

Do not spray or paint insecticidal material on the surface of the unit.

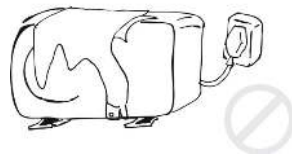

Do not block the evaporator by paper or any other foreign bodies, to keep the unit well ventilated.

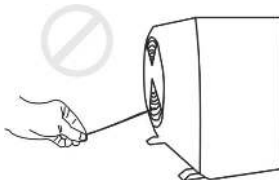

Do not touch the air outlet grill when fan motor is running.

Children should be supervised to ensure that they do not play with the appliance.

This appliance is not intended for use by persons (including children) with reduced physical, sensory or mental capabilities, or lack of experience and knowledge, unless they have been given supervision or instruction concerning use of the appliance by a person responsible for their safety.

VITAL: Unless you are certain the heat pump has always remained in its upright installation orientation during transit and throughout the installation process, and has not been laid on its side or end at any time, the heat pump should NOT be used for 24 hours after its installation to prevent damage to the compressor.

- The heat pump is pre-installed with a power cable for direct power connection to a suitable power point. If the installer decides to connect power to the heat pump from a source, all electrical connections must be performed by a licensed electrician and must confirm to all national, state and local electrical codes in effect at the time of installation.
- The heat pump must be connected to a suitable rated and weather protected power supply. The supply line should be a dedicated power circuit and means for disconnection must be incorporated in the fixed wiring in accordance with your local wiring regulations. Means for disconnection from the supply mains should have a contact separation in all poles that provide full disconnection under over voltage Category III conditions.
- The appliance contains no serviceable parts. Do not attempt service of this appliance. Contact your dealer or authorized service agent for assistance.
- Turn the mains power OFF before touching or modifying any cable connection.
- Low voltage or improper wiring may cause damage to this appliance. Read and follow all wiring instructions when connecting to power supply.
- If the supply cord is damaged, it must be replaced by the manufacturer, its service agent or similarly qualified persons in order to avoid a hazard.
- This appliance must not be installed in proximity to highly flammable materials.
- Water temperature in excess of 38oC may cause hyperthermia (heat stress).
- It is the installer's responsibility to ensure the floor or mounting base is capable of supporting the expected load of the heat pump and an adequate drainage system has to be provided in case of overflowing or leaking water.
- The heat pump should be plumbed after the spa filters and NOT before, to prevent foreign objects or debris from entering heat pump.

WARNING: When ambient temperatures are close to or under freezing point, water circulation to the heat pump should never be stopped for more than 4 hours without completely draining the heat exchange. **In areas where freezing conditions are prevalent and sustained, in advance of any freeze event, all water MUST be removed from the entire heat pump water circuit. Please refer to the "Winterising" section of this manual. FREEZE DAMAGE NOT COVERED UNDER PRODUCT WARRANTY**

2. Technical Description

2.1 Specifications

Model	SHP-60P	SHP-80P	SHP-140	SHP-170	SHP-190
Power supply	230V~, 50Hz	230V~, 50Hz	230V~, 50Hz	230V~, 50Hz	230V~, 50Hz
Heating consumption power* (kW)	1.1	1.5	2.6	3.1	3.4
Heating restored power* (kW)	6	8.3	14	17	19.5
Heating nominal intensity* (A)	5.3	7.2	12.8	15	19
Cooling absorptive power* (kW)	1.2	1.6	2.7	3.2	3.5
Cooling restored power* (kW)	4.3	5.8	9.7	11.5	14.5
Cooling nominal intensity* (A)	5.8	7.8	13.6	16	20.3
Air flow (m ³ /h)	1700	1700	3200	4000	4000
Noise level (d(B)A)	<48	<49	<52	<53	<54
Refrigerant gas	R410a	R410a	R410a	R410a	R410a
Rate of average filling of gas (g)	620	850	1450	1650	2100
Net weight of the unit (kg)	51	55	77	97	100
Overall sizes L x W x H (cm)	99x36 x62	99x36 x62	112x48 x84	112x48 x84	112x48 x84

* Possible variations of value according to climatic conditions

** Heating by max ambient temperature: 27°C

*** Cooling by max ambient temperature: 43°C

3. Touch Pad Operation

3.1 LCD Display and Touch Pad Control

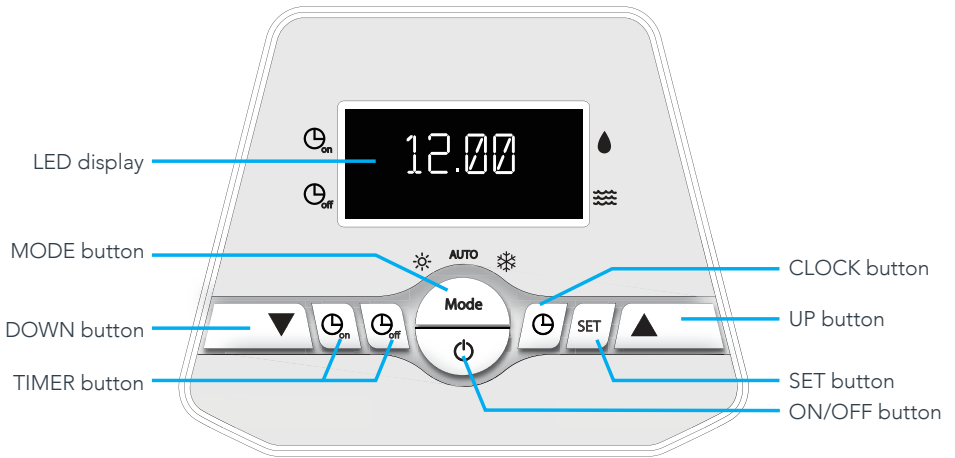

No	Meaning	Range	Change	Factory Setting
0	Cooling setting water temperature	10 - 27°C	YES	27
1	Heating setting water temperature	10 - 27°C	YES	27
2	Turnround of defrosting under heat mode	30 - 90 min	YES	45 min
3	Defrosting start temperature	-30 - 0°C	YES	-7°C
4	Defrosting exit temperature	2 - 30°C	YES	13°C
5	Time of exit defrost under heat mode	1 - 12min	YES	5 min
6	Mode (cool/cool&heat/electric heat/heat)	0/1/2/3	YES	1
7	Mode of electronic expansion valve (0 for 'MAN' and 1 for 'AUTO')	0/1	NO	1
8	Heating Target Superheat	-15 - 15°C	NO	3°C
9	Cooling Target Superheat	-15 - 15°C	NO	3°C
A	Auto mode setting water temperature	10 -27°C	YES	27
b	Compressor protection exhaust temperature	85 - 110°C	NO	95°C
c	Low ambient temperature protection	-20 - 10°C	YES	-7°C
d	Manual control for EE valve	18 - 94	NO	70
E	Water temperature	-9 - 99°C	Measured value	
F	Compressor exhaust temperature	-9 - 125°C	Measured value	
G	Heating coil temperature	-9 - 99°C	Measured value	
H	Return gas temperature	-9 - 99°C	Measured value	
L	Ambient temperature	-9 - 99°C	Measured value	
N	Cooling temperature	-9 - 99°C	Measured value	
P	Actual open steps of EE valve	N*5	Measured value	

3.2 Set the Operation Parameter

1. Press & hold the "SET" button for 5 seconds to enter the operation parameter setting interface.
2. Press ▲ or ▼ to check parameter.
(parameter from 0-P, see Operation Parameter Table).
3. Under parameter, press "SET" to start setting (the parameter displayed blinks). Press ▲ or ▼ to set data for parameter from 0-d. Press "SET" again to exit the current parameter settings.
4. Wait for 5 seconds. The LCD screen will display the water temperature (If heat pump is running) or the current time (if the heat pump is OFF).
5. Whilst the unit is running, you can press & hold the "SET" button for 5 seconds to check the current parameter, but you cannot change the value.



Parameter 0: Cooling setting water temperature (10-45°C).
Factory setting: 27°C



Parameter 1: Heating setting water temperature (10-45°C).
Factory setting: 27°C



Parameter 2: Turnround if defrosting under heat mode (30-90 min).
Factory setting: 45 minutes

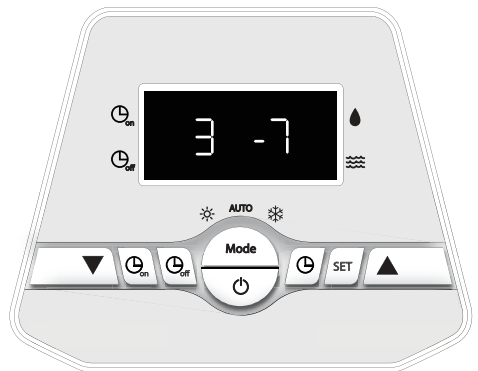

Parameter 3: Defrosting start temperature (-30-0°C).
Factory setting: -7°C

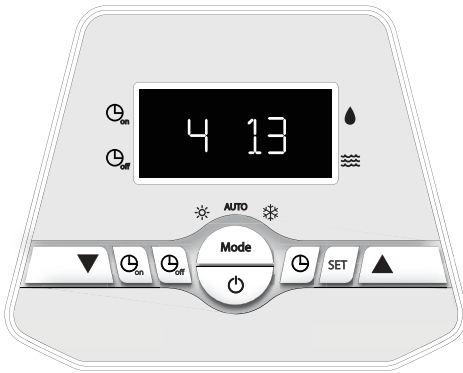

Parameter 4: Defrost exit temperature.
(2-30°C)
Factory setting: 13°C

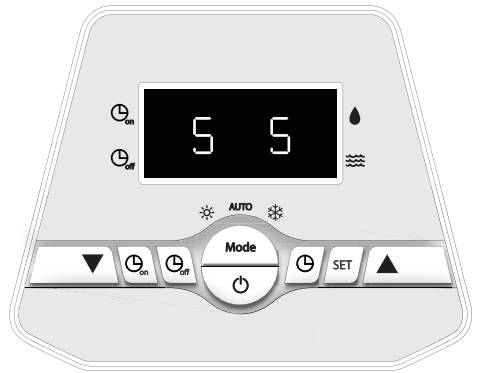

Parameter 5: Time of exit defrost under heat mode (1-12 min)
Factory setting: 5 minutes

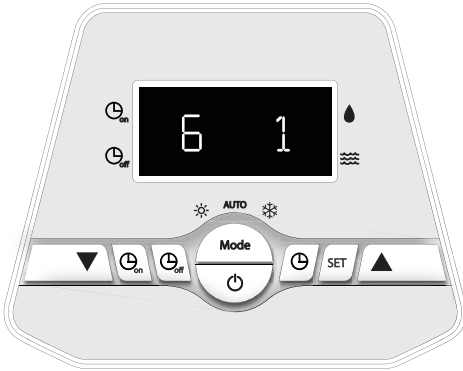

Parameter 6: Mode (0/1/2/3)
Factory setting: 1

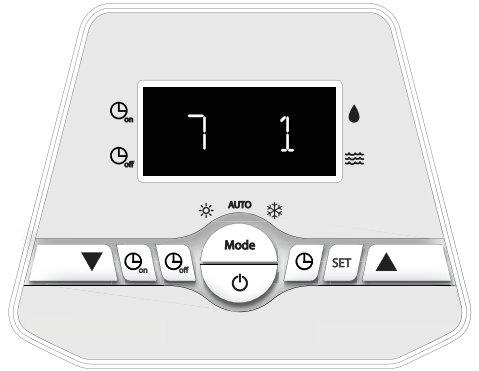

Parameter 7: Mode of electronic expansion valve (0 for 'MANUAL' and 1 for 'AUTO'). Factory setting: 1

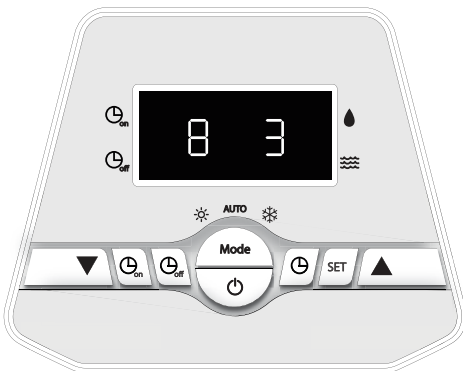

Parameter 8: Heating target superheat (-15-15°C). Factory setting: 3°C

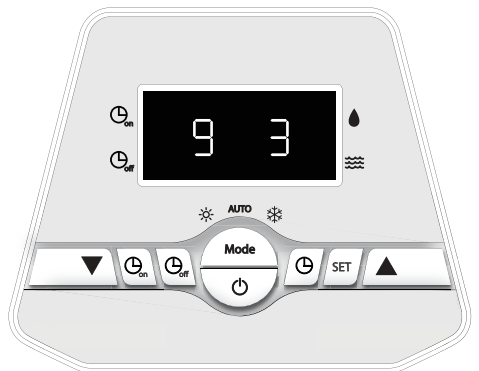

Parameter 9: Cooling target superheat (-15-15°C). Factory setting: 3°C

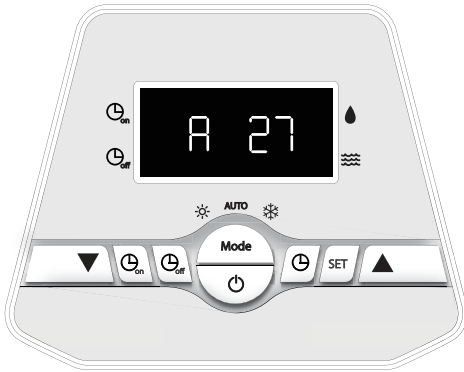

Parameter A: Auto mode setting water temperature (10-45°C).
Factory setting: 27°C

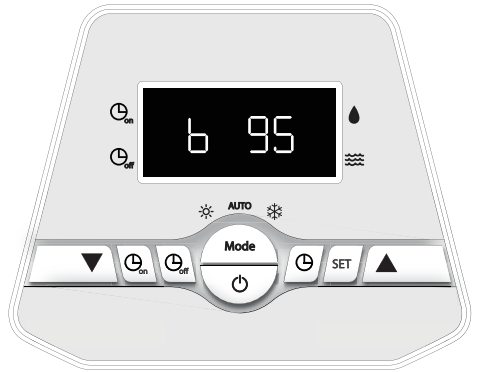

Parameter b: Compressor protection exhaust temperature for heating (85-110°C).
Factory setting: 95°C

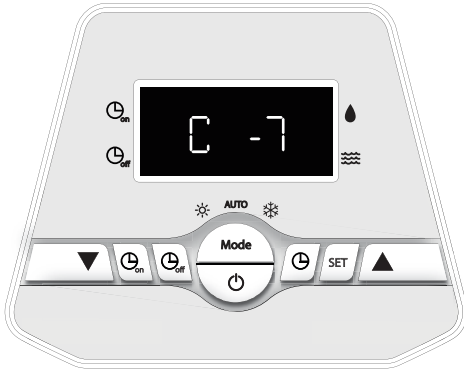

Parameter C: Low ambient temperature protection (-20-10°C).
Factory setting: -7°C

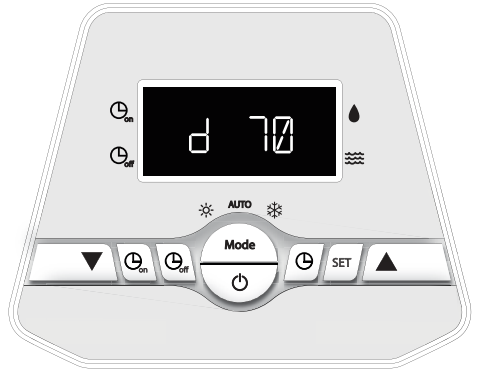

Parameter d: Manual control for EE valve (18-94).
Factory setting: 70

3.3 Powering the Unit

Press  to power on the unit. Whilst ON, the LED displays the water temperature.

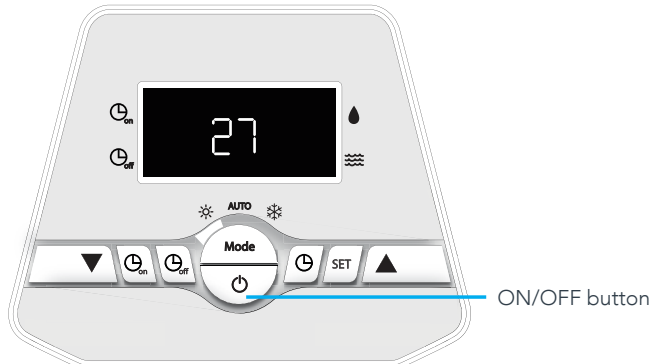

3.4 Selecting the Operation Mode

Press "MODE" to choose mode. The mode can only be changed while ON.

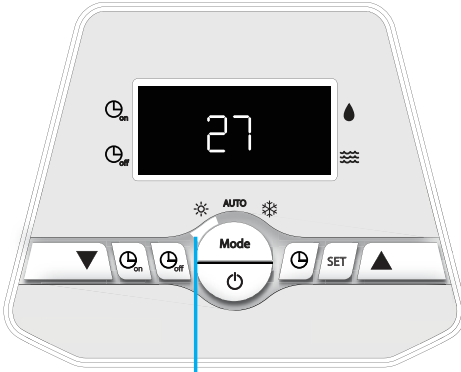

Heating mode

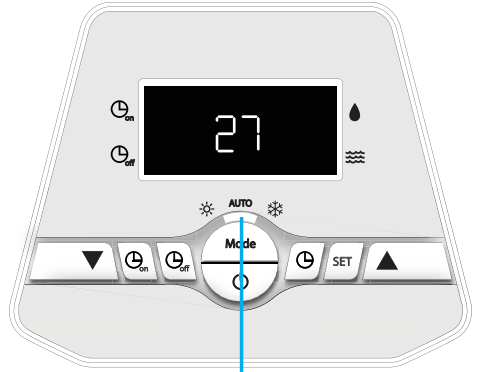

Auto mode

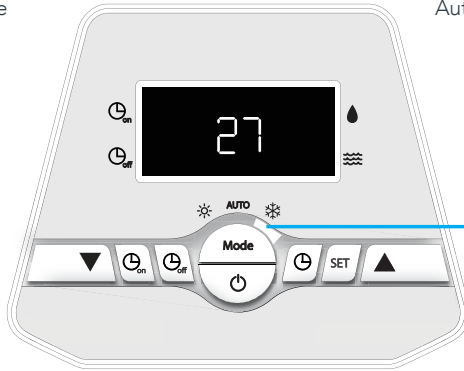

Cooling mode

3.5 Setting Temperature

Press ▲ to set temperature 1°C higher, press ▼ to set temperature 1°C lower.



3.6 Check Current Temperature

When ON, press the "SET" button for 5 seconds and ▲ or ▼ to check the current status of the unit. You can check the Water Temp-/Compressor protection exhaust Temp-/Heat Copper Temp-/Return Gas Temp-/Ambient Temp-/Cooling Copper Temp-/ Actual open steps of EE valve. If no buttons are pressed within 5 seconds, the LED will display the water temperature. When the unit is switched OFF, the current time is displayed.

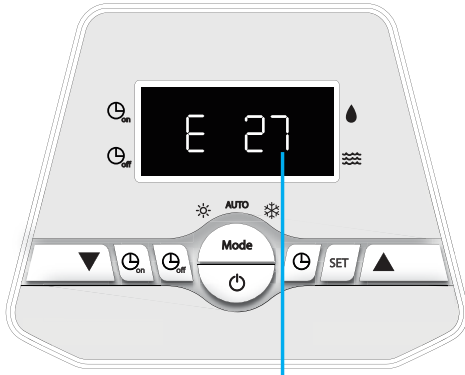

Water temperature

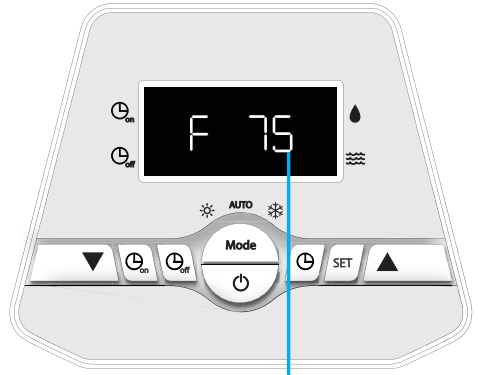

Compression protection exhaust temperature

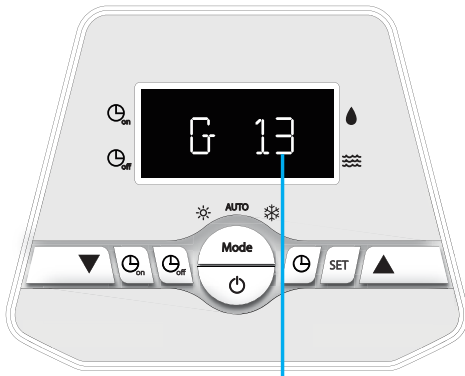

Heating copper temperature

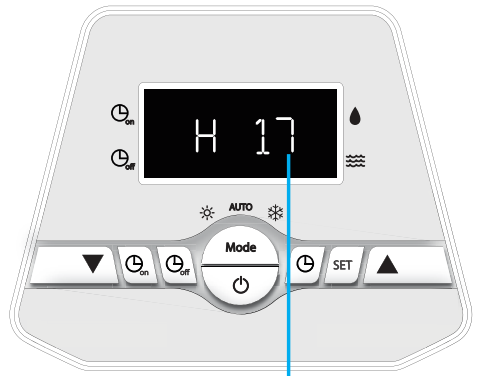

Return gas temperature

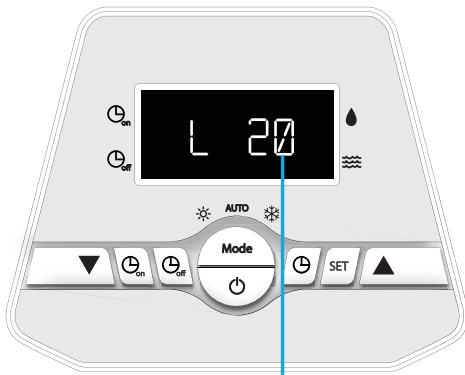

Ambient temperature

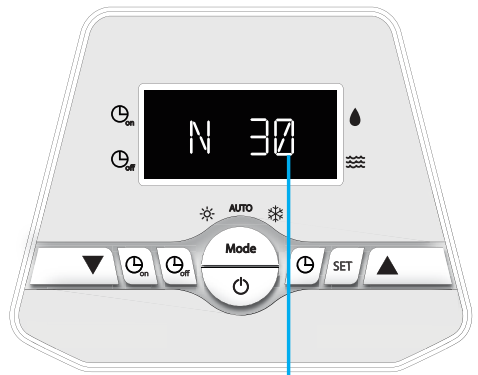

Cooling copper temperature

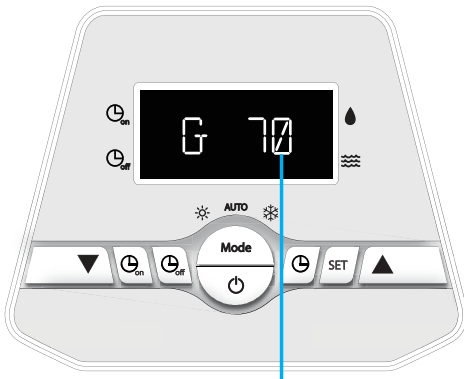

Actual open steps of EE valve

3.7 Setting the Time

Press the button to set the time. When the time displayed blinks, press the button again and then use the arrows and to change the hour setting. To change the minutes, press the button again using the and arrows. Once the correct time is set, press the button again to set. The display should return to normal.

3.8 Timer ON/OFF

Press the button to set the time. When the time displayed blinks, press the button again and then use the arrows and to change the hour setting. To change the minutes, press the button again using the and arrows. Once the correct time is set, press the button again to set. The display should return to normal.

Press the button to set the time. When the time displayed blinks, press the button again and then use the arrows and to change the hour setting. To change the minutes, press the button again using the and arrows. Once the correct time is set, press the button again to set. The display should return to normal.

The time setting is a 0 to 24 hours cycle.

To deactivate the timer press the button. When the display blinks, press the to deactivate TIMER.

3.9 Coercive Defrosting

1. Press button for 5 seconds when the unit is in heating mode.
The unit will then go to defrost state.
2. When the defrosting conditions are met, defrosting will stop automatically.
3. After 30 seconds, the unit will switch to heat mode again.

3.10 Key Lock

Press and for 3 seconds, to set key lock.
Press and for 3 seconds again to release key lock.

4. Safety and Control Systems

Heat pumps are equipped with the following standard safety control systems:

4.1 Water Flow Switch

The water flow switch ensures that the heat pump does not work when the filter pump is faulty (and the water is not circulating). This control system also stops the heat pump if the water circulation is cut off or stopped.

4.2 Refrigerant Gas High-and-Low Pressure Protection

The high pressure protection system ensures the heat pump is not damaged in case of over-pressurization of the gas. The low pressure protection emits a signal when refrigerant is escaping from the conduits and the unit cannot function.

4.3 Overheating Protection on the Compressor

This protects the compressor from overheating.

4.4 Automatic Defrost Control

When the air is very humid and cold, ice can form on the evaporator. When this happens, a thin layer of ice appears that will become bigger as the heat pump is running. When the temperature of the evaporator gets too low, the automatic defrost control system will be activated. This system will reverse the heat pump cycle so that hot refrigerant gas is sent through the evaporator during a brief period of time to defrost it.

4.5 Anti-frost Protection During Winter

This protection can only be activated if the heat pump is in STAND-BY mode.

4.5.1 First Anti-frost Protection

If the filter pump is controlled by the heat pump (regardless of the value for parameter 9), when the water temperature is between 2 and 4°C and the air temperature is lower than 0°C, the filter pump will be automatically turned on to prevent the water from freezing in the piping. This protection system will deactivate automatically when the temperature rises again.

4.5.2 Second Anti-frost Protection

If the water temperature drops even more, that is, below 2°C (during long frost periods), the heat pump will also start running to heat the water until its temperature reaches 3°C. When this minimum temperature is reached, the heat pump will stop, but anti-frost protection will remain active until conditions change.

4.6 Three Phase Protection

If the phases are connected in the wrong order due to electrical mis-wiring, this protection system will interrupt the power supply to prevent damage to the unit. There will be an EE 4 error code on the display.

5. Installation

5.1 Recommended Air Flow Requirements

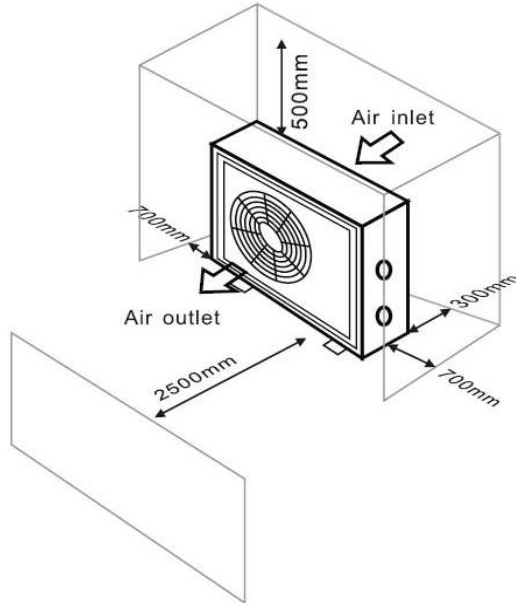

- The series of heat pumps must be located outside in a clean area where air flow will not be restrictive. The heat pump must be located external to the spa pool cabinet to allow sufficient air flow for optimum efficiency.
- The heat pump must operate with a clean air supply so should be situated away from vegetation and obstacles.

WARNING: The heat pump MUST be installed according to the air space requirements shown in Figure 1. Failure to follow these instructions may VOID WARRANTY.

5.2 Location of the Unit

Select a suitable location in accordance with below notes and consult the local swimming pool safety regulations to check requirements for proximity to other equipment.

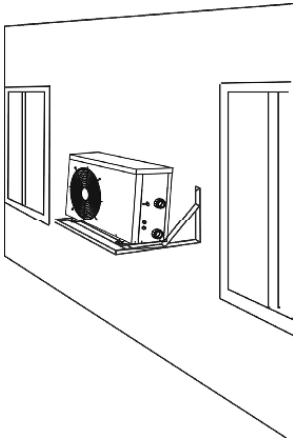

Install on wall

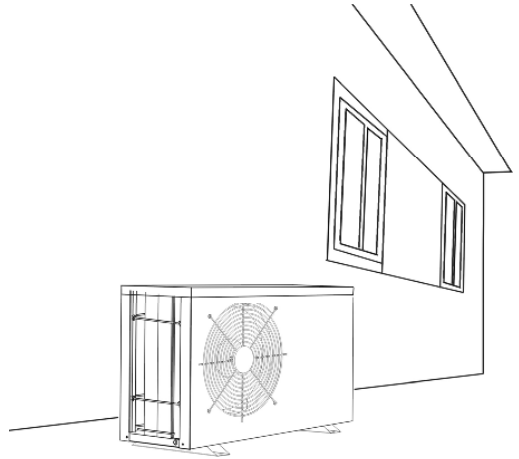

Install on ground

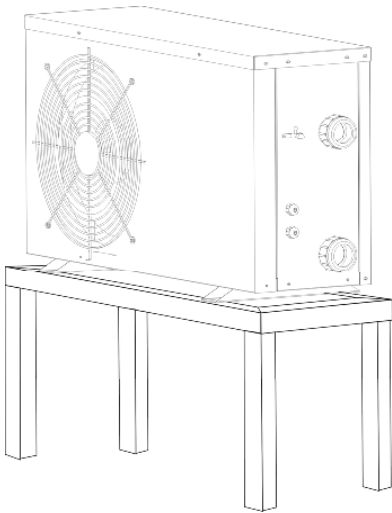

Install on stand

IMPORTANT: Installation location notes

1. The heat pump must be installed on a flat, solid and large enough base to properly secure the heat pump. Whilst it can be mounted on brackets or stands a level concrete base is preferred.
2. If installing the heat pump in a harsh climatic area (i.e. sub-zero temperatures, snow, humidity), it is recommended to raise the unit 50cm above the ground.
3. During installation, ensure sufficient free space is left around the heat pump for future maintenance.
4. The unit is air cooled. It must be installed outdoor in an area with sufficient clearance to provide enough air circulation through evaporator.
5. DO NOT install heat pump in a confined space to prevent recycling of air.
6. The fan should not blow towards windows, walls or spaces likely to be inhabited by people or animals.

7. Do not install where the heat pump is likely to be subjected to polluted air, dust or debris etc.
8. Avoid directing fan output against the dominant wind directions.
9. Protect the heat pump from possible snow fall.
10. Minimise exposure to environmental conditions as much as possible and never block the airflow.
11. Ensure the heat pump is installed in an area that is free from flammable and corrosive chemicals, and grease.

5.3 Installation of Water Pipes

Glued Union Fittings:

1. Ensure both tail piece and locking ring are screwed/fitted to the heat pump and tightened before gluing water pipe to union tail. This will ensure the tail piece has an even seal against the o-ring.
2. Use PVC priming fluid on end of water pipe and union tails before gluing. Once primed glue pipes into place and ensure pipes are running straight and square into heat pump.

IMPORTANT: Ensure the pipe work running from the heat pump to the spa pool is supported. DO NOT have long runs of pipe in mid-air above the ground without support. Ideally return the pipes to ground level as they exit the heat pump to ensure the pipe work is self-supporting.

*NOTE: Once the pipe work is full of water it will become heavy and will place strain on the heat pump outlets if the pipe work is not supported. In the case of glued union fittings, if the pipe work is unsupported the strain could cause stress damage to the outlets and potential leaks. **IT IS THE INSTALLER'S RESPONSIBILITY TO ENSURE THE PIPE WORK IS ADEQUATELY SUPPORTED AND RESTRAINED TO PREVENT MOVEMENT AND STRESS.***

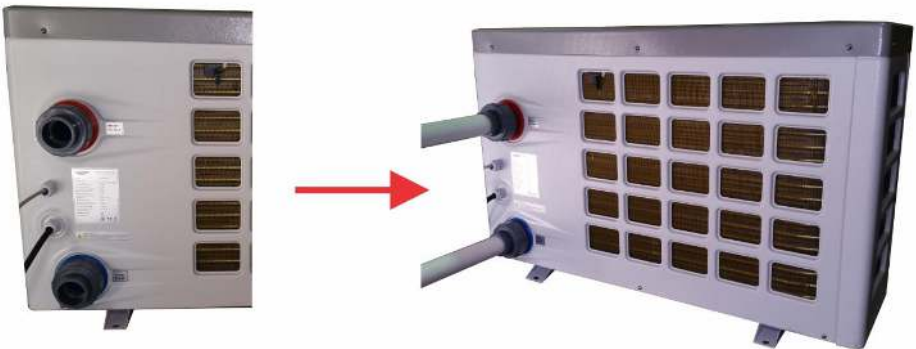

5. 4 Heat Pump Plumbing Diagram

Connection is carried out with a by-pass located on the circuit of filtration, upstream of the chemical treatment unit.

Connect intake/outlet water PVC pipes (DN50) to the inlet / outlet ports as indicated (grease the threads before fixing)

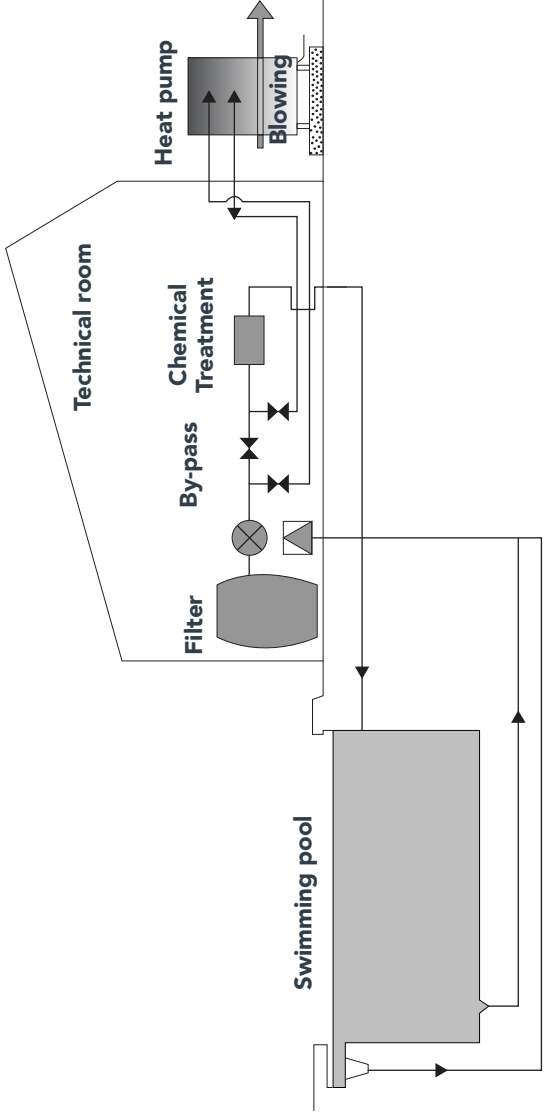

5.5 Electrical Connection

CAUTION: before connecting the heat pump, make sure that the main circuit is isolated and disconnected.

All electrical connections must be performed by a licensed electrician and must conform to all national, state and local electrical codes in effect at the time of installation.

The heat pump must be connected to a suitable rated and weather protected power supply. The supply line should be a dedicated power circuit and means for disconnection must be incorporated in the fixed wiring in accordance with your local wiring regulations.

Means for disconnection from the supply mains should have a contact separation in all poles that provide full disconnection under over Voltage Category III conditions.

Characteristics of the electric supply:

- 230 V +/- 10%, single-phase current, or 380 V +/- 10%, three-phase current, 50 Hz - Mode of neutral TT and TN.S; the circuit of heat pump must be connected to an earth circuit.

Characteristic minimum of the protection:

- Protection must be of 16 A, by circuit breaker or fuse; it must protect the Heat pump exclusively; the circuit breaker must be specified with curve D, the fuse must be specified Am.
- Differential protection : 30 mA (the length of cable between the connector block of the heat pump and the circuit breaker / fuse should not exceed 12 m).

Control:

The heat pump is fitted with a water flow switch which is used to signal the software card when the water flow is sufficient.

The heat pump can also directly control filtration pump operation using a contacting relay (not supplied). Please contact us for further information if you wish to configure the heat pump in this way.

The recommended water flow is 5m³/h.

6. Water Flow and Refrigerating Circuit Pressure

After installation, set the pressure of the refrigerant circuit to ensure optimal operation of the heat pump, as follows:

Stage 1:

Before starting the Heat Pump, the ambient temperature should be around 20°C, & the refrigerant meter shows pressure between 14 - 16kg/cm².

Stage 2:

Close the by-pass valve and open the large inlet and outlet valves of the heat pump so that all of the water flow goes through the heat pump.



Set the Heat Pump in heating mode, wait for the indicated pressure to stabilize; the correct setting of the pressure is between 21 - 35 kg/cm²;
In most cases (where filtration pump provides a flow rate up to 9m³/h) you do not have to open the by pass valve.

If the stabilized pressure is under 21kg/cm², the progressive opening of the by-pass valve will allow this pressure to increase.

When the adjustment/calibration of the by-pass valve is complete, you should not have to further adjust it once set.

7. Problematic Environmental Conditions

Under certain conditions the heat exchanges between the refrigerant and the water and between the fluid and the air is insufficient. The consequence is that the refrigerating circuit runs at a higher than normal pressure and the compressor consumes more electricity.

The temperature sensors' compressor outlet and the magnetic circuit breaker on the compressor power supply, protect the compressor from these extreme conditions. When this occurs the error message EE 05 is displayed.

The conditions causing this situation is as follows:

In heating mode:

- Insufficient water flow: close the by-pass valve to increase the refrigerant exchange ⇔ water.

In cooling mode:

- Excess water flow: open the by pass valve to decrease the water flow and so the exchange water ⇔ refrigerant.
- Insufficient air flow: be sure that the net of the condenser is not blocked.

Note: these error codes are likely to occur if temperature of the swimming pool water is high and the temperature is hot.

8. Maintenance and Inspection

8.1 Maintenance

- Check the water inlet and drainage often.
The water and air inflow into the system should be sufficient so that its performance and reliability does not get compromised.
You should clean the pool filter regularly to avoid damage to the unit caused by clogging of the filter.
- The area around the unit should be spacious and well ventilated. Clean the sides of the heat pump regularly to maintain good heat exchange to save energy.
- Check if all aspects of the unit are operational and pay special attention to the

- operation pressure of the refrigerant system.
- Check the power supply and cable connections regularly. Should the unit begin to function abnormally or should you notice a smell from an electrical component, arrange for repair or replacement.
- Winterizing : make sure to purge all the water from the heat pump and other systems in order to prevent frost damage.
- You should also purge the water if the unit will not work for an extended period of time. You should check all parts of the unit thoroughly and completely fill the system with water before turning it on.

8.2 Troubleshooting Guide

Improper installation may result in an electrical discharge that could lead to death of – or serious injury to -pool users, installers or others due to electrical shock and may also cause damage to your property.

DO NOT attempt to modify the internal configuration of the heat pump.

- Keep your hands and hair clear of the fan blades to avoid injury.
- If you are not familiar with your pool filtering system and heat pump:
 - a. Do not attempt to adjust or service without consulting your dealer or your professional pool or air conditioning contractor.
 - b. Read the entire installation and user manual before attempting to use, service or adjust the unit.
 - c. Start the heat pump at least 24 hours after its installation in order to prevent damage to the compressor.

Note: Switch off the power prior to maintenance or repairs.

8.3 Overview of Possible Error Codes Displayed on the Screen

Go back to chapter 4 “Protection systems” for more detailed information. The heat pump screen displays one of the following codes:

Display	Problem	Cause	Solution
PP 1	“WATER IN” sensor out of order	Sensor open or short-circuited	Check or replace the sensor
PP 2	“Compressor exhaust” sensor out of order	Sensor open or short-circuited	Check or replace the sensor
PP 3	“EVAPORATOR PIPE” sensor out of order	Sensor open or short-circuited	Check or replace the sensor
PP 4	“Return Gas” sensor out of order	Sensor open or short-circuited	Check or replace the sensor
PP 5	“AIR” sensor out of order	Sensor open or short-circuited	Check or replace the sensor
PP 6	“Condenser PIPE” sensor out of order	Sensor open or short-circuited	Check or replace the sensor

PP7	Water temperature too low during cool-down	Insufficient water flow	Check the water flow
		Sensor "WATER OUT" displays an incorrect message	Check or replace the sensor
PP 7	First anti-frost protection active	Low temperatures for water and air	No action required
PP 7	Second anti-frost protection active	Low temperatures for water and air	No action required
PP 8	"CONDENSER" sensor out of order	Sensor open or short-circuited	Check or replace the sensor
PP 9	Low ambient temperature protection	Ambient temperature is too low or protection temperature setting set too high	Check and repair
EE 1	High pressure protection	Insufficient water flow	Check the water flow
		Pressure switch out of order	Replace the pressure switch
		Too much refrigerant gas present	Have the heat pump checked by a refrigeration technician
EE 2	Low pressure protection	Not enough refrigerant gas	Have the heat pump checked by a refrigeration technician x62
		Leak in the cooling conduits	Have the heat pump checked by a refrigeration technician
EE 3	Insufficient water flow	Insufficient water flow	Check the water flow
		Water flow switch out of order	Replace the Water flow switch
EE 4	Phase Protection	Faulty phase wiring	Put phases in order
EE 5	Compressor exhaust temperature is too high	Water temperature and environmental temperature is too high	Set to the safety of water temperature.
		Refrigerant leakage	Check and repair.
		Insufficient water flow	Check the water flow
EE 6	Communication failure	No communication between the digital display and the system controller	Check the connection between the screen and the controller.
			Replace screen and/or controller.
PE1	Emergency switch disconnect	Emergency switch disconnect	Check and repair

Spa Net Pty Ltd
4/103 Railway Road North,
Mulgrave NSW 2756, Australia

Phone: +61 2 4587 7766

Facsimile: +61 2 4587 8766

Email: service@spanet.com.au

Website: www.spanet.com.au

